

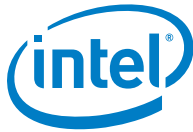

Intel[®] Quark SoC X1000 Debug Operations

User Guide

January 2014



Contents

- 1 Introduction4
 - 1.1 Terminology5
 - 1.2 Related Documents.....5
- 2 JTAG Interface.....7
 - 2.1 SKU-Based JTAG Debug Capability7
 - 2.2 CLTAPC Instruction Table7
 - 2.3 CLTAPC Data Register Table.....8
 - 2.3.1 CLIDCODE.....8
 - 2.3.2 CLBYPASS8
 - 2.3.3 CLTAPC_SELECT8
 - 2.3.4 CLTAPC_CPU_VPREQ9
 - 2.3.5 CLTAPC_CPU_TAPSTATUS10
 - 2.3.6 CLTAPC_CPU_VPRDY10
 - 2.3.7 CLTAPC_TAPNW_STATUS10
- 3 Putting It All Together12
 - 3.1 Initial JTAG Discovery12
 - 3.2 Check Core Powergood.....12
 - 3.3 Add Core TAP to the JTAG Chain.....12
 - 3.4 Verify Core IDCODE.....13
- 4 JTAG Interface.....14
 - 4.1 TAP Instruction Table.....14
- 5 Run Control.....15
 - 5.1 Introduction to Probe Mode.....15
 - 5.2 Probe Mode Entry15
 - 5.3 Probe Mode Exit16
 - 5.4 Reset Break.....16
 - 5.5 TAPSTATUS Register.....16
 - 5.6 Accessing Architectural Registers.....17
 - 5.6.1 Submitting Instructions to the Core17
 - 5.6.1.1 Instruction Faults.....17
 - 5.6.2 EIP Management18
 - 5.6.3 DR7 Management.....18
 - 5.6.3.1 EIP and Software Breakpoints.....18
 - 5.6.4 WRITEPIR Register Format18
 - 5.6.5 Register Read19
 - 5.6.6 Register Write.....19
 - 5.6.7 Special Cases for Register Access19
 - 5.6.7.1 PMCR.....19
 - 5.6.7.2 Register Access after HLT Instruction Execution19
 - 5.6.8 Checking for HALT State.....20
 - 5.6.9 Pseudo Opcodes for Architectural Register Access20
 - 5.6.10 Probe Mode Control Register21
 - 5.6.11 Accessing Model Specific Registers (MSR)22



5.7	Reading and Writing Memory	22
5.7.1	Management of Architectural Registers for Memory Access	22
5.7.1.1	DS Selector	23
5.7.1.2	Adjust CPL Prior to Memory Access.....	23
5.7.1.3	Disable Interrupts Prior to Memory Access.....	23
5.7.1.4	Processor Cache Flush Prior to Memory Access	23
5.7.1.5	CRO	23
5.7.2	Memory Read	24
5.7.3	Memory Write	24
5.8	Reading and Writing I/O Ports	24
5.8.1	I/O Read.....	24
5.8.2	I/O Write	24
5.9	Hardware Breakpoints.....	25
5.10	Software Breakpoints.....	25
5.11	Single Step.....	25
5.12	Redirections into Probe Mode	25
5.12.1	Shutdown Break.....	25

Figures

Figure 1.	Intel® Quark SoC X1000	4
-----------	------------------------------	---

Tables

Table 1.	Terminology	5
Table 2.	Related Documents	5
Table 3.	CLTAPC TAP Instructions.....	7
Table 4.	CLTAPC TAP Data Registers	8
Table 5.	CLTAPC_SELECT	8
Table 6.	CLTAPC_CPU_VPREQ	9
Table 7.	CLTAPC_CPU_TAPSTATUS	10
Table 8.	CLTAPC_TAPNW_STATUS	11
Table 9.	TAP Instructions	14
Table 10.	TAPSTATUS Data Register	16
Table 11.	Register Access PIR Values.....	21
Table 12.	PMCR Description.....	22
Table 13.	DS Selector Values for Memory Access	23

1 Introduction

The Intel® Quark SoC X1000 processor is the next generation secure, low-power Intel® Architecture (IA) SoC for deeply embedded applications. The SoC integrates the Intel® Quark SoC X1000 Core plus all the required hardware components to run off-the-shelf operating systems and to leverage the vast x86 software ecosystem. For details, see the *Intel® Quark SoC X1000 Datasheet*.

The Intel® Quark SoC X1000 Core (codenamed Lakemont) enables a range of low-cost, high-performance embedded system designs capable of running applications written for the Intel architecture. The Intel® Quark SoC X1000 Core integrates a 16-Kbyte unified cache and floating-point hardware onchip for improved performance. For further details, including the Intel® Quark Core feature list, see the *Intel® Quark SoC X1000 Core Hardware Reference Manual* and *Intel® Quark SoC X1000 Core Developer's Manual*.

This document assumes that the reader has some familiarity with JTAG based debug tools and the use of JTAG for run control of an execution core.

This document provides details on JTAG based debug for any product based on the Intel® Quark SoC X1000.

Figure 1. Intel® Quark SoC X1000

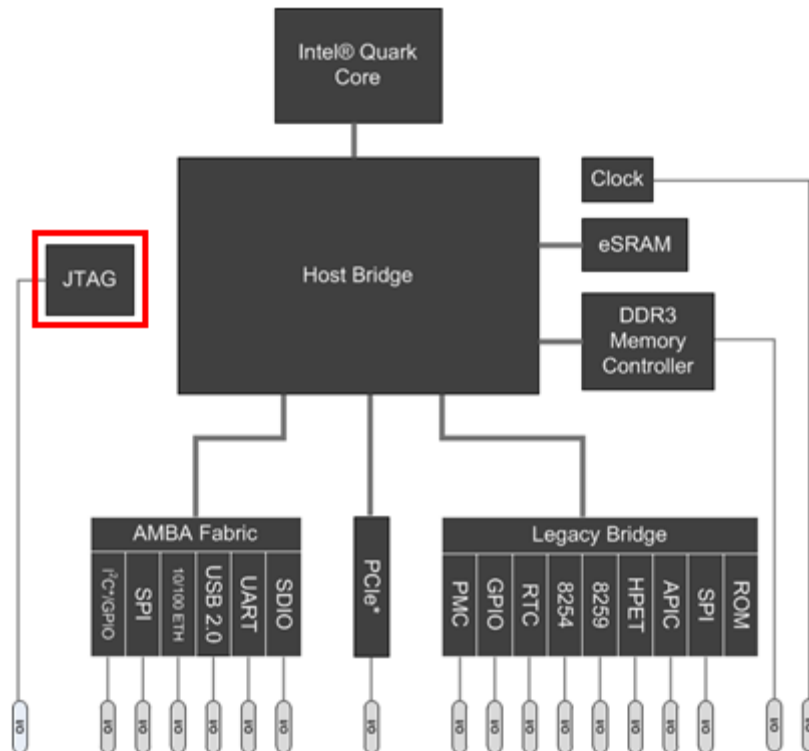



1.1 Terminology

Table 1. Terminology

Term	Description
ACPI Sx states	System sleep states as defined by the ACPI standard: http://www.acpi.info/
CLTAPC	Chip level TAP Controller. This is the top level standard compliant TAP controller for the SoC.
Debug Software	Generic term for software that controls a hardware probe connected to the JTAG pins.
JTAG	"Joint Test Action Group" of the IEEE. This is now a generic term to refer to the TAP and the pins used for communication with TAPs.
PIR	Probe Mode Instruction Register
PRDY#	Probe Mode Ready package pin (active low); this pin is used to signal to Debug Software that the core has entered Probe Mode
PREQ#	Probe Mode Request package pin (active low); this pin may be used by Debug Software to request that the core enter Probe Mode
SoC	System on chip
TAP	Test Access Port as defined by the IEEE 1149.1-1990 (including IEEE 1149.1a-1993), "IEEE Standard Test Access Port and Boundary-Scan Architecture"
TDI	TAP Data In; the serial data input pin for the TAP chain
TDO	TAP Data Out; the serial data output pin for the TAP chain
TDR	TAP Data Register; a serial TAP data register selected by a TAP instruction

1.2 Related Documents

Table 2. Related Documents

Title and Location	Document #
Intel® Quark SoC X1000 Datasheet https://communities.intel.com/docs/DOC-21828	329676
Intel® Quark SoC X1000 Core Hardware Reference Manual https://communities.intel.com/docs/DOC-21825	329678
Intel® Quark SoC X1000 Core Developer's Manual https://communities.intel.com/docs/DOC-21826	329679



Title and Location	Document #
Intel® 64 and IA-32 Architectures Software Developer Manuals contain details on architectural registers: http://www.intel.com/content/www/us/en/processors/architectures-software-developer-manuals.html	Multiple volumes



2 JTAG Interface

The Intel® Quark SoC X1000 has the standard set of JTAG pins, TCLK, TDI, TDO, TMS, and TRST# on the package which are routed to a debug header on the system board.

The SoC exposes a single IEEE compliant TAP by default, called the 'Chip-Level TAP Controller' (CLTAPC). This TAP provides some basic system status and has the ability to 'add' child TAP controllers to the serial JTAG chain.

Debug Software tools that wish to provide run control for the Intel® Quark SoC X1000 must interact with the CLTAPC to add the CPU core to the JTAG chain. The Debug Software may also use TAP data registers (TDRs) in the CLTAPC to monitor system status. The CLTAPC provides some features related to run control of the core which is described in detail in [Section 5](#).

2.1 SKU-Based JTAG Debug Capability

Not all SKUs of the Intel® Quark SoC X1000 ship with JTAG debugging enabled. To receive details on how to enable JTAG on these SKUs, contact your Intel account team.

2.2 CLTAPC Instruction Table

Table 3. CLTAPC TAP Instructions

Function/Category	Instruction Mnemonic	Opcode (8 bits)	TDR Name
SOC IDCODE	CLIDCODE	0x02	CLIDCODE
BYPASS	CLBYPASS	0xFF	CLBYPASS
TAP NETWORK	CLTAPC_SELECT	0x11	CLTAPC_SELECT
IA Run Control	CLTAPC_CPU_VPREQ	0x51	CLTAPC_CPU_VPREQ
	CLTAPC_CPU_TAPSTATUS	0x52	CLTAPC_CPU_TAPSTATUS
	CLTAPC_CPU_VPRDY	0x53	CLTAPC_CPU_VPRDY
TapNW Status	CLTAPC_TAPNW_STATUS	0x69	CLTAPC_TAPNW_STATUS
RESERVED	-	All other values	-



2.3 CLTAPC Data Register Table

Table 4. CLTAPC TAP Data Registers

TDR Name	TDR Length (Bits)	Reset Mechanism	Access
CLIDCODE	32b	TRST/SYNC TAP RST	Read-Only
CLBYPASS	1b	TRST/SYNC TAP RST	Read-Write
CLTAPC_SELECT	64b	TRST/SYNC TAP RST	Read-Write
CLTAPC_CPU_VPREQ	8b	PWR_GOOD [†]	Read-Write
CLTAPC_CPU_TAPSTATUS	8b	PWR_GOOD [†]	Read-Only
CLTAPC_CPU_VPRDY	1b	PWR_GOOD [†]	Read-Write
CLTAPC_TAPNW_STATUS	64b	PWR_GOOD [†]	Read-Write

[†] The external power supply signal is used for PWR_GOOD. These values survive a board reset if the power supply is still connected to the board.

2.3.1 CLIDCODE

The CLTAPC IDCODE register is 32 bits in size. This value may be used by Debug Software to confirm there is a working JTAG connection to the board and to confirm the identity of the SoC.

The Intel[®] Quark SoC X1000 IDCODE is 0x0E681013.

2.3.2 CLBYPASS

This is the IEEE standard BYPASS data register; it is one bit in size.

2.3.3 CLTAPC_SELECT

This data register contains bits that control the presence of the children TAPs in the SoC on the JTAG chain.

Table 5. CLTAPC_SELECT

CLTAPC_SELECT			
Bit Number	Name	Reset Value	Comments
1:0	CPUCORE_TAP_SEL	2'b00	2'b01 = Normal; 2'b10 = Excluded; 2'b11 = Shadow
63:2	RESERVED	2'b00	RESERVED

When bits 1:0 are set to the value 01 by Debug Software, the CPU Core TAP is added to the JTAG chain immediately after the CLTAPC.



The chain order becomes TDI →CLTAPC →CPU_CORE_TAP →TDO.

All other bits in this register are reserved.

2.3.4 CLTAPC_CPU_VPREQ

The CLTAPC has control over an internal PREQ wire connected to the core. This provides Debug Software the ability to use some PREQ based debug features when connected using JTAG pins alone.

This data register contains bits that control the assertion of the internal 'PREQ' signal to the Intel® Quark SoC X1000 Core and reset break behavior.

Table 6. CLTAPC_CPU_VPREQ

CLTAPC_CPU_VPREQ			
Bit Number	Name	Reset Value	Comments
0	assert_vpreq	1'b0	Assert PREQ to Core
1	enable_preq_on_reset	1'b0	Enable PREQ assertion on Reset
2	enable_preq_on_reset_2	1'b0	Enable PREQ assertion Reset Source 2
7:3	RESERVED	1'b0	RESERVED

When bit 0 is set to 1 by Debug Software, the PREQ signal connected to the core will be asserted. This signal is an external request to the core that causes the core to break and enter Probe Mode.

Arm resetbreak for the core by setting bits 'enable_preq_on_reset' (bit 1) and 'enable_preq_on_reset_2' (bit 2). When these bits are set and the core receives a RESET event, the Core will immediately break and enter Probe Mode instead of executing the first instruction. The core will enter Probe Mode with the CS register set to 0xF000 and the EIP register set to 0x0000FFF0. The instruction located at this address has not been executed when a resetbreak triggered the entry to Probe Mode.

All other bits in this register are reserved.

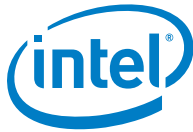

2.3.5 CLTAPC_CPU_TAPSTATUS

This data register contains status bits related to the Run Control features in the CLTAPC_CPU_VPREQ register.

Table 7. CLTAPC_CPU_TAPSTATUS

CLTAPC_CPU_TAPSTATUS			
Bit Number	Name	Reset Value	Comments
0	vpreq_asserted	1'b0	PREQ was asserted via one of the sources in CPU_VPREQ
1	prdy_asserted	1'b0	PRDY was asserted by the Core
2	preq_asserted_via_reset	1'b0	PREQ was asserted via Reset Source 1.
3	preq_asserted_via_reset_2	1'b0	PREQ was asserted via Reset Source 2.
7:4	RESERVED	4'b0000	RESERVED

2.3.6 CLTAPC_CPU_VPRDY

This data register is used to reset the status bits in the CLTAPC_CPU_TAPSTATUS register when it is written to. It is a single bit in size, but the value written does not matter.

2.3.7 CLTAPC_TAPNW_STATUS

This data register contains a mixture of status bits. Bit 0 will be 1 when the Core TAP has been added to the JTAG chain using the CLTAPC_SELECT instruction.

Bits 33 to 34 provide details on the current ACPI Sx state. The Core is awake and running only when the SoC/System is in S0, 'S0_power_ok' (bit 34) is 1.

Bit 35 must be 1 before the Core TAP may be added to the JTAG Chain.

If the Core is not awake, it cannot be added to the JTAG chain and cannot be available for run control.



Table 8. CLTAPC_TAPNW_STATUS

CLTAPC_TAPNW_STATUS			
Bit Number	Name	Reset Value	Comments
0	cltapnw_en[CPUCORETAP_SEL]	0x0	Returns 1 when the IA Core TAP is in the JTAG Chain
31:1	RESERVED	0x0	RESERVED
32	S5_power_ok	0x0	S5_power_ok Status
33	S3_power_ok	0x0	S3_power_ok Status
34	S0_power_ok	0x0	S0_power_ok Status
35	jtag_valid	0x0	When the SoC is in S0, this bit must be 1 before the Core TAP may be added to the JTAG chain
63:36	RESERVED	0x0	RESERVED

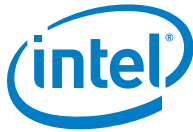

3 Putting It All Together

This section uses the reference information from [Section 2](#) to put together all of the steps required for Debug Software to prepare the target for Core run control.

3.1 Initial JTAG Discovery

There are two methods available for Debug Software to confirm that it has a good connection to the Chip-Level TAP Controller before moving on to debug the Intel® Quark SoC X1000 Core.

- Using a TAP Reset
 - Issue a JTAG reset by asserting and then de-asserting the TRST# pin, or by holding TMS to 1 for five TCLK cycles. Both mechanisms are part of the IEEE 1149.1 standard for a TAP reset.
 - Use a 32 bit or DR Shift using the TAP finite state machine and examine the data captured on TDO. It should match the Intel® Quark SoC X1000 CLTAPC IDCODE (0x0E681013).
- Without a TAP Reset
 - Shift in the IR Opcode for the CLTAPC IDCODE data register (0x2) and then a 32 bit DR Shift. The data collected on TDO should match the CLTAPC IDCODE.

3.2 Check Core Powergood

Once the Debug Software has verified that it has a working connection to the SoC, it can check to see if the Core is powered.

Using a JTAG DR Shift to read the CLTAPC_TAPNW_STATUS data register, check that bit 34, 'S0_power_ok' is set to 1. When this bit is a 1, it is safe to access the Core's TAP.

3.3 Add Core TAP to the JTAG Chain

The Core TAP is added to the JTAG chain by setting its 'select' bits in the CLTAPC_SELECT data register. The data value used to add the core is the 64 bit value: 0x00000000_00000001. The Core TAP is added to the JTAG chain when the TAP finite state machine (FSM) enters Update-DR. The Debug Software should move the TAP FSM to Run-Test/Idle immediately after writing any bits in CLTAPC_SELECT. Until the select bits are cleared, Debug Software must be prepared to account for the fact that there are two TAPs on the chain.

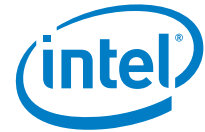

3.4 Verify Core IDCODE

After completing the steps above, the Debug Software can then verify that the Core TAP is in the JTAG chain. The 8 bit IR Opcode for the Core IDCODE data register is 0x2. The Core IDCODE value is 0x18289013.

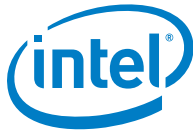

4 JTAG Interface

4.1 TAP Instruction Table

The Intel® Quark SoC X1000 Core TAP uses an 8-bit instruction register. The following table describes all IR opcode encodings.

Table 9. TAP Instructions

IR Opcode	TAP Command	Description	DR Size (Bits)	Values
0x02	IDCODE	The IEEE 1149 compliant IDCODE	32	
0x03	SUBMITPIR	Submit the contents of the PIR to the core	0	
0x04	PROBEMODE	Enter and Exit Probe Mode (Details in Section 5.1)	1	1: Enter Probe Mode 0: Exit Probe Mode
0x06	WRITEPIR	Write instruction opcodes to the PIR	64	
0x08	RWPDR	Select the PDR chain for read or write	32	
0x0B	TAPSTATUS	TAP Status register	32	See Table 10 .
0xFF	BYPASS	IEEE 1149 BYPASS instruction	1	
All other values	BYPASS	IEEE 1149 BYPASS instruction	1	

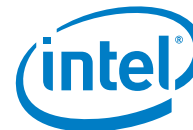

5 Run Control

5.1 Introduction to Probe Mode

Probe Mode is a debug mode of the processor in which the normal execution sequence is interrupted. The processor enters a dormant state where architectural state can be viewed and modified. The state extraction/modification is performed with the help of the TAP. Special hardware/software products are developed to make use of Probe Mode.

The processor can be made to enter Probe Mode in various ways. The PREQ (Probe Mode Request) pin, called PREQ# is pulsed to cause Probe Mode entry. The processor can also be configured to enter Probe Mode when certain events occur (redirecting to Probe Mode).

Once the processor enters Probe Mode and is ready to accept commands, it pulses the PRDY (Probe Mode Ready) pin, called PRDY#. Debug Software can then issue Probe Mode instructions (to be described later) to access architectural state. When an instruction is submitted while the processor is in Probe Mode, PRDY# is pulsed upon completion of the instruction.

While in Probe Mode, all the communication between the Debug Software and the processor is done through the TAP. The Probe Mode instructions are serially sent via the WRSUBPIR instruction into the TAP that then transfers the instruction bytes to the fetch unit.

Probe Mode Entry on Intel processors is an interrupt/exception style event and is prioritized with other events. The priority is very low.

5.2 Probe Mode Entry

Probe Mode may be entered asynchronously (from the Core's perspective) by the request of debug software using two mechanisms: the PREQ# pin and the TAP. Both the CLTAPC and the Core TAP in the Intel® Quark SoC X1000 have TAP instructions for requesting entry into Probe Mode.

Some systems using the Intel® Quark SoC X1000 may not route the PREQ# and PRDY# pins to the Debug Tool's connector on the board. In these cases, the Debug Software must rely only on the TAP for all debug activities.

The Core will pulse PRDY# for two bus clock cycles and this pulse is latched by the CLTAPC_CPU_TAPSTATUS TDR.

The Core may be configured to enter Probe Mode when a code or data breakpoint match occurs. These appear to be asynchronous entries in to Probe Mode from the perspective of the Debug Software since it cannot predict when or if the breakpoint match will occur. Any standard Debug Exception (#DB) from the core may be



configured to cause an entry to Probe Mode instead of allowing the exception handler to run. See the [Probe Mode Control Register](#) section below for full details.

The PREQ pin must be pulsed to enter Probe Mode. The PROBEMODE TAP instruction offers a TAP-based entry method as an alternative. To use the TAP-based Probe Mode entry, write '1 to the PROBEMODE data register. The core will automatically redirect to Probe Mode after a single step, hardware or software breakpoint. All entries to Probe Mode are signaled to the Run Control Hardware via the PRDY# pin.

Note: The core requires that TCLK be running for it to latch PREQ# pin events for Probe Mode entry.

5.3 Probe Mode Exit

Probe Mode exit is accomplished by writing a '0 to the PROBEMODE TAP instruction's data register. Reset will also cause the core to leave Probe Mode.

5.4 Reset Break

In order to debug BIOS or firmware from the first instruction, the reset break capability must be used. The Intel® Quark SoC X1000 Core supports reset break with two mechanisms. The first option depends on the PREQ# and PRDY# signals being connected to the Hardware Probe. The second option is available for when the Debug Tool is connected using only the JTAG pins.

Mechanisms for reset break:

1. Run Control hardware must monitor the target for RESET events so that it may assert PREQ# prior to the rising edge of RESET# as sampled by the core.
2. Use the CLTAPC_CPU_VPREQ TDR detailed in [Section 2.3.4](#).

5.5 TAPSTATUS Register

The TAPSTATUS register is defined in the following table.

Table 10. TAPSTATUS Data Register

Bit Field	Description
31:7	Reserved
6	Shutdown Break Occurred. This bit is set to '1 when a shutdown break was the cause for the break.
5	Shutdown Break is enabled. This is a copy of PMCR[1]
4	If '1, the core supports software breakpoints installed by debug software
3	Probe Mode Redirection. Holds value of PMCR[0].
2	Probe Mode In Progress. Held high while in Probe Mode and after register state has been saved to shadow SRAM.

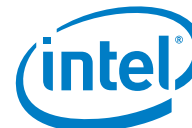

Bit Field	Description
1	Probe Mode Request. Held high on Enter Probe Mode Request, reset once register state has been saved to shadow SRAM.
0	Probe Mode Ready, this is a copy of the PRDY# signal. Since PRDY# is pulsed for a short number of clocks this may never be seen as '1'.

5.6 Accessing Architectural Registers

The architectural registers are copied to an internal SRAM upon entry to Probe Mode and may be accessed in any order. Debug software must cache the values of any register that may be changed in the SRAM during Probe Mode operations like memory access. These cached values must be written to the SRAM prior to releasing the processor from Probe Mode when handling the 'go' command. Full details on register reads and writes are in [Section 5.6.5](#) and [Section 5.6.6](#).

5.6.1 Submitting Instructions to the Core

The Probe Mode Instruction Register (PIR) is used via two TAP instructions:

- The WRITEPIR TAP data register allows the debug tool to write instruction opcodes into the TAP. Once the WRITEPIR data register is populated, the opcodes are submitted to the core for execution using the SUBMITPIR TAP instruction.
- SUBMITPIR is an 'IR Only' TAP command; there is no corresponding data register.

The following instructions are supported by the Core while in Probe Mode:

- Memory Read and Write via MOV r, m8/m16/m32 and MOV m8/m16/m32, r
- I/O Read and Write via IN and OUT
- MSR Read and Write via RDMSR and WRMSR
- The WBINVD and INVVD instructions
- The CPUID instruction

Note: The PG bit in the CR0 register must be 0 before submitting instructions to the core for execution.

5.6.1.1 Instruction Faults

Instructions submitted via the TAP that are executed by the core may generate faults. The debug software should make every attempt to verify that instructions used by the software internally do not fault. However, the user is free to submit any instruction or data that may result in a fault. Some potential faults: page fault, segment violation, or accessing an undefined MSR.

If a fault occurs:

- The core will not re-enter Probe Mode and Run Control Hardware will not see a pulse on the PRDY# pin.

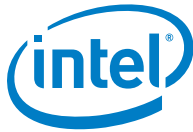

- The core may enter the SHUTDOWN state, depending on the side effects of the fault. For example, if a valid IDT is not set up or the fault handlers are not present in memory, the core may enter SHUTDOWN.

Debug software can watch for PRDY# timeouts after submitting instructions to the core. If a timeout occurs, debug software may attempt to force the core back into Probe Mode via the PREQ# pin or the PROBE MODE TAP instruction. If the core has entered SHUTDOWN, there may be no other option other than resetting the core to restart instruction execution.

5.6.2 EIP Management

The core automatically resets EIP after each instruction while in Probe Mode. This is done to prevent segment violations and triggering breakpoints while in Probe Mode.

5.6.3 DR7 Management

While the core is in Probe Mode, debug software must write the value of 0x00000000 to the DR7 register. This is needed to disable any data or I/O breakpoints while the core is halted. This is the reset value for DR7 for this architecture.

5.6.3.1 EIP and Software Breakpoints

Software breakpoints behave as instruction traps in the Intel® Quark SoC X1000 Core. After entering Probe Mode due to a software break point trigger, the EIP register points to the instruction immediately after the 0xF1 opcode used for the breakpoint. Debug software must check for software breakpoint matches using EIP – 1 when determining the break cause and replacing the displaced opcode byte when resuming execution from the break address.

5.6.4 WRITEPIR Register Format

The 64-bit WRITEPIR TAP data register allows ITP to submit instruction opcodes for execution by the core. If the instruction submitted by Debug software does not use all 64 bits, the remaining bytes must be 'padded' with NOP instructions, opcode 0x90. The data value must be transformed using a two-step process prior to the addition of the NOP pads.

The following sample using the instruction MOV EAX, DWORD PTR [EDX] illustrates this process.

The opcodes for this instruction used in this sample are 0x66678B02.

- Rearrange the byte order, moving the least significant byte to the most significant byte:
 - 0x66678B02 becomes 0x20B87666
- Reverse the bits in each byte:
 - 0x20B87666 becomes 0x40D1E666
- Add the NOP opcode to create the full 64 bit value:
 - 0x40D1E666 becomes 0x0909090940D1E666



5.6.5 Register Read

The template to read a register:

1. Find the PIR value for the desired register in [Table 11](#) below.
 - a. Use WRITEPIR to shift in the 64-bit value from the table.
 - b. Shift in SUBMITPIR TAP instruction.
2. Write the 'SRAMACCESS' pseudo opcode (from [Table 11](#) below) to the PIR.
3. Shift in SUBMITPIR TAP instruction.
4. Write the 'SRAM2PDR' pseudo opcode (from [Table 11](#) below) to the PIR.
5. Shift in SUBMITPIR TAP instruction.
6. Use the RWPDR TAP instruction to read the 32 bits of data.

5.6.6 Register Write

The template to write a register:

1. Shift the data to be written in to the TAP PDR.
2. Find the PIR value for the desired register in [Table 11](#) below.
 - a. Use WRITEPIR to shift in the 64-bit value from the table.
 - b. Shift in SUBMITPIR TAP instruction.
3. Write the 'SRAMACCESS' pseudo opcode (from [Table 11](#) below) to the PIR.
4. Shift in SUBMITPIR TAP instruction.
5. Write the 'PDR2SRAM' pseudo opcode (from [Table 11](#) below) to the PIR.
6. Shift in the SUBMITPIR TAP instruction.

5.6.7 Special Cases for Register Access

5.6.7.1 PMCR

This register in the SRAM is write-only; reads return all zeros.

5.6.7.2 Register Access after HLT Instruction Execution

If the core has executed the HLT instruction and is in the 'HALT' state when Probe Mode entry occurs, the following registers are read-only in the SRAM:

- CR2
- DR0-DR3 (hardware breakpoints may not be added or removed in this state)
- PMCR

See [Checking for HALT State](#) below for details.

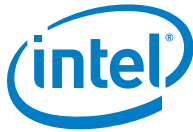

5.6.8 Checking for HALT State

When the core executes the HLT instruction, it stops instruction execution and places the processor in a HALT state. Any of the following will resume execution:

- Enabled interrupt (including NMI and SMI)
- Debug exception
- BINIT# signal
- INIT# signal
- RESET# signal

If an interrupt (including NMI) is used to resume execution after a HLT instruction, the saved instruction pointer (CS:EIP) points to the instruction following the HLT instruction.

The core also emits a special bus cycle alerting other agents on the bus that the core has entered HALT. This will be used by SoCs integrating the core to clock gate and/or power down the core. Because the core is powered down or clock-gated while in the HALT state, debug software may never find the core is in HALT after entering Probe Mode.

The debugger can determine if the core is in HALT by reading the HALT register from the SRAM and checking bit 16. If bit 16 is 1, the core is in the HALT state.

5.6.9 Pseudo Opcodes for Architectural Register Access

Each register in [Table 11](#) is described in detail in the Intel Software Developer's Manuals here: <http://www.intel.com/content/www/us/en/processors/architectures-software-developer-manuals.html>



Table 11. Register Access PIR Values

Register	64 Bit PIR Value	Register	64 Bit PIR Value	Register	64 Bit PIR Value
CR0	0x000000001D660000	TSSlimit	0x000000181D660000	CSlimit	0x0000000C1D660000
CR3	0x000000801D660000	IDTar	0x000000981D660000	ESar	0x0000008C1D660000
EFLAGS	0x000000401D660000	IDTbase	0x000000581D660000	ESbase	0x0000004C1D660000
EIP	0x000000C01D660000	IDTlimit	0x000000D81D660000	ESlimit	0x000000CC1D660000
EDI	0x000000201D660000	GDTar	0x000000381D660000	CR4	0x0000002C1D660000
ESI	0x000000A01D660000	GDTbase	0x000000B81D660000	SIP	0x000000AC1D660000
EBP	0x000000601D660000	GDTlimit	0x000000781D660000	TMPD	0x0000006C1D660000
ESP	0x000000E01D660000	LDTar	0x000000F81D660000	TMPB	0x000000EC1D660000
EBX	0x000000101D660000	LDTbase	0x000000041D660000	TMPC	0x0000001C1D660000
EDX	0x000000901D660000	LDTlimit	0x000000841D660000	HALT	0x0000009C1D660000
ECX	0x000000501D660000	GSar	0x000000441D660000	REV	0x0000005C1D660000
EAX	0x000000D01D660000	GSbase	0x000000C41D660000	BASE	0x000000DC1D660000
DR6	0x000000301D660000	GSlimit	0x000000241D660000	PDR6	0x0000003C1D660000
DR7	0x000000B01D660000	FSar	0x000000A41D660000	CR2	0x000000BC1D660000
TR	0x000000701D660000	FSbase	0x000000641D660000	DR0	0x0000007C1D660000
LDTR	0x000000F01D660000	FSlimit	0x000000E41D660000	DR1	0x000000FC1D660000
GS	0x00000081D660000	DSar	0x000000141D660000	DR2	0x000000021D660000
FS	0x000000881D660000	DSbase	0x000000941D660000	DR3	0x000000821D660000
DS	0x000000481D660000	DSlimit	0x000000541D660000	PMCR	0x000000421D660000
SS	0x000000C81D660000	SSar	0x000000D41D660000	SRAMACCESS	0x0000000E9D660000
CS	0x000000281D660000	SSbase	0x000000341D660000	SRAM2PDR	0x4CF0000000000000
ES	0x000000A81D660000	SSLimit	0x000000B41D660000	PDR2SRAM	0x0CF0000000000000
TSSar	0x000000681D660000	CSar	0x000000741D660000		
TSSbase	0x000000E81D660000	CSbase	0x000000F41D660000		

5.6.10 Probe Mode Control Register

This register contains only one bit: the IR bit. When this bit is set, all debug exceptions (#DB) are converted to Probe Mode entry. This bit must be set for all types of instruction steps and when hardware breakpoints are installed. If the core adds support for software breakpoints, this bit would be set to enable them as well.

This register is accessible via the TAP and through the SRAM. The pseudo opcode PIR value for this register in the SRAM is 0x000000421D660000.

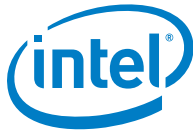

Table 12. PMCR Description

PMCR	Description
Bit 0	IR bit, when set all debug exceptions are converted into Probe Mode entry event.
Bit 1	Shutdown Redirection, when this bit is set to '1 SHUTDOWN events cause an entry to Probe Mode.

5.6.11 Accessing Model Specific Registers (MSR)

MSRs may be accessed (read and written) using the following flow:

1. Write the MSR index value to the ECX register using normal SRAM write operation.
2. Read:
 - a. Submit an 'rdmsr' instruction to the core via WRITEPIR and SUBMITPIR.
 - b. Bits 31:0 of the MSR data will be in EAX; bits 63:32 of the MSR data will be EDX.
3. Write:
 - a. Move bits 31:0 of the data to be written to EAX; move bits 63:32 of the data to EDX.
 - b. Submit a 'wrmsr' instruction to the core via WRITEPIR and SUBMITPIR.

5.7 Reading and Writing Memory

Memory may be read and written using the Intel® Quark SoC X1000 Core by direct injection of the macro-instructions via the TAP's PIR register. The core will:

1. Restore all register states from the shadow SRAM.
2. Exit Probe Mode.
3. Execute the single instruction.
4. Re-enter Probe Mode.
5. When the re-entry to Probe Mode completes, the PRDY# pin is pulsed to indicate to debug software that the core is ready for the next instruction.

If the memory access fails, the PRDY# pin will not signal that the instruction completed. Debug software may use this to detect failures and attempt to force the core back into Probe Mode or let the user know that the core must be reset.

5.7.1 Management of Architectural Registers for Memory Access

All register reads and writes used as part of memory accesses are performed using the pseudo opcodes to interact with the SRAM. Only the MOV instructions used for the actual read or write are executed by the core. The MOV instructions must be written to the WRITEPIR data register using the standard NOP padding and byte reversal.

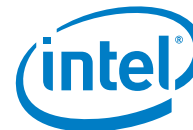

5.7.1.1 DS Selector

The DS selector must be changed before debug software can access the full 4GB address space while in Probe Mode. Prior to any memory access, the registers listed in the following table must be set to the values specified for each. Debug software must take care to read these registers after Probe Mode entry and cache the values so that they may be restored prior to Probe Mode exit.

Table 13. DS Selector Values for Memory Access

Register	Value
DS Base	0x00000000
DS Limit	0xFFFFFFFF
DS AR	0x004F9300

5.7.1.2 Adjust CPL Prior to Memory Access

The code-privilege level in effect prior to Probe Mode entry may prevent the use of the WBINVD instruction needed to flush the cache. Debug software must set the CPL to 0 in both the CS access byte and the SS access byte if they are non-zero as part of the architectural save-state process. This is done by changing bits 13 and 14 in the SSAR and CSAR registers to zero. If they are zero upon Probe Mode entry, Debug software does not need to change them.

5.7.1.3 Disable Interrupts Prior to Memory Access

The processor must not be allowed to handle pending interrupts when it is released from Probe Mode to handle memory reads/writes. Interrupt handling is disabled by setting the IF bit in the EFLAGS register to 0.

5.7.1.4 Processor Cache Flush Prior to Memory Access

If enabled prior to Probe Mode entry, the cache must be flushed and disabled prior to any memory access from ITP. If the CR0.CD bit is 0, the following steps must be performed:

1. Perform the actions described in Sections [5.7.1.1](#), [5.7.1.2](#), and [5.7.1.3](#).
2. Set CR0.PG to 0, if it is 1.
3. Submit WBINVD instruction.
4. Set CR0.NW and CR0.CD bit.
5. Set CR0.PG to 1, if it had been 1 in step 2.

Debug software must restore all architectural registers to the values they contained after Probe Mode entry before releasing the core to continue normal execution.

5.7.1.5 CR0

The value of the CR0.PG (paging enabled) bit influences memory reads and writes. To read from a physical memory address provided by the user or during address translation, Debug software must set the CR0.PG to bit to '0. Memory reads and writes



using linear, two-field virtual, and three-field virtual must first be translated to the physical address form before being used to read or write memory.

5.7.2 Memory Read

1. Clear CR0.PG bit if it is 1.
2. Write address to EAX.
3. Submit the read instruction to the core: MOV EDX, DWORD PTR [EAX].
4. Read memory data from EDX via the SRAM and PDR.
5. Restore CR0.PG bit if it was changed in the first step.

5.7.3 Memory Write

1. Clear CR0.PG bit if it is 1.
2. Write address to EAX.
3. Write data to EDX.
4. Submit the memory write instruction to the core: MOV DWORD PTR [EAX], EDX.
5. Restore the CR0.PG bit if it was changed in the first step.

5.8 Reading and Writing I/O Ports

The Intel® Quark SoC X1000 Core supports I/O port reads and writes using the IN and OUT instructions submitted to the core via the TAP.

Note: The CR0.PG bit must be 0 prior to using the PIR TAP instructions to submit I/O read and write instructions.

5.8.1 I/O Read

1. Write the I/O address to read from to the DX register.
2. Submit one of the following based on the desired access width:
 - 1 byte wide read: IN AL, DX
 - 2 byte wide read: IN AX, DX
 - 4 byte wide read: IN EAX, DX

5.8.2 I/O Write

1. Write the I/O address for the write to the DX register.
2. Write the data to be written to the EAX register.
3. Submit one of the following based on the desired access width:
 - 1 byte wide write: OUT DX, AL
 - 2 byte wide write: OUT DX, AX
 - 4 byte wide write: OUT DX, EAX



5.9 Hardware Breakpoints

1. Write the linear address to DR0-3.
2. Set DR6 and DR7 bits as needed.
3. Set bit 0 in PMCR to convert the #DB exception to a Probe Mode entry.

5.10 Software Breakpoints

To determine if an instance of the Intel® Quark SoC X1000 Core supports software breakpoints, check bit 4 in the TAPSTATUS register. If the bit is `1, the core supports software breakpoints.

Configure software breakpoints in the Core by replacing one byte of the original instruction opcode(s) in memory with the value 0xF1 and setting PMCR[IR] to `1.

5.11 Single Step

1. Set EFLAGS[TF] to `1 and PMCR[IR] to `1.
2. Release from Probe Mode and wait for PRDY#.

On Probe Mode entry from SW break, debug software must decrement EIP by 1 before replacing the 0xF1 with the real opcode byte.

5.12 Redirections into Probe Mode

5.12.1 Shutdown Break

The processor may be configured to enter Probe Mode when a SHUTDOWN event occurs. This is enabled by setting bit 1 in the PMCR register to `1.

To determine if the cause for an asynchronous entry into Probe Mode was caused by a shutdown break, bit 6 in the TAPSTATUS data register will be set to `1. PMCR bit 5 holds a copy of the enable bit in PMCR. This allows debug software to check if the shutdown redirection is enabled without putting the core into Probe Mode.



Revision History

Date	Revision	Description
January 2014	002	Added value for CSar in Table 11 .
November 2013	001	First release of document.

INFORMATION IN THIS DOCUMENT IS PROVIDED IN CONNECTION WITH INTEL PRODUCTS. NO LICENSE, EXPRESS OR IMPLIED, BY ESTOPPEL OR OTHERWISE, TO ANY INTELLECTUAL PROPERTY RIGHTS IS GRANTED BY THIS DOCUMENT. EXCEPT AS PROVIDED IN INTEL'S TERMS AND CONDITIONS OF SALE FOR SUCH PRODUCTS, INTEL ASSUMES NO LIABILITY WHATSOEVER AND INTEL DISCLAIMS ANY EXPRESS OR IMPLIED WARRANTY, RELATING TO SALE AND/OR USE OF INTEL PRODUCTS INCLUDING LIABILITY OR WARRANTIES RELATING TO FITNESS FOR A PARTICULAR PURPOSE, MERCHANTABILITY, OR INFRINGEMENT OF ANY PATENT, COPYRIGHT OR OTHER INTELLECTUAL PROPERTY RIGHT.

A "Mission Critical Application" is any application in which failure of the Intel Product could result, directly or indirectly, in personal injury or death. SHOULD YOU PURCHASE OR USE INTEL'S PRODUCTS FOR ANY SUCH MISSION CRITICAL APPLICATION, YOU SHALL INDEMNIFY AND HOLD INTEL AND ITS SUBSIDIARIES, SUBCONTRACTORS AND AFFILIATES, AND THE DIRECTORS, OFFICERS, AND EMPLOYEES OF EACH, HARMLESS AGAINST ALL CLAIMS COSTS, DAMAGES, AND EXPENSES AND REASONABLE ATTORNEYS' FEES ARISING OUT OF, DIRECTLY OR INDIRECTLY, ANY CLAIM OF PRODUCT LIABILITY, PERSONAL INJURY, OR DEATH ARISING IN ANY WAY OUT OF SUCH MISSION CRITICAL APPLICATION, WHETHER OR NOT INTEL OR ITS SUBCONTRACTOR WAS NEGLIGENT IN THE DESIGN, MANUFACTURE, OR WARNING OF THE INTEL PRODUCT OR ANY OF ITS PARTS.

Intel may make changes to specifications and product descriptions at any time, without notice. Designers must not rely on the absence or characteristics of any features or instructions marked "reserved" or "undefined". Intel reserves these for future definition and shall have no responsibility whatsoever for conflicts or incompatibilities arising from future changes to them. The information here is subject to change without notice. Do not finalize a design with this information.

The products described in this document may contain design defects or errors known as errata which may cause the product to deviate from published specifications. Current characterized errata are available on request.

Contact your local Intel sales office or your distributor to obtain the latest specifications and before placing your product order.

Copies of documents which have an order number and are referenced in this document, or other Intel literature, may be obtained by calling 1-800-548-4725, or go to: <http://www.intel.com/design/literature.htm>

Intel, and the Intel logo are trademarks or registered trademarks of Intel Corporation or its subsidiaries in the United States and other countries.

*Other names and brands may be claimed as the property of others.

Copyright © 2014, Intel Corporation. All rights reserved.