

ROVIO™



Mobile Webcam
with TrueTrack™ Navigation System

WowWee™
TECHNOLOGIES



User manual

Item No. 8033

Copyrights and acknowledgements

Skype, Skype logo and S logo are trademarks or registered trademarks of Skype Limited.

Microsoft, Windows and Windows NT are registered trademarks of Microsoft Corporation in the United States and other countries.

Windows Vista is a trademark of the Microsoft group of companies.

Windows Live is a registered trademark of Microsoft Corporation.

Mac and Mac OS are trademarks of Apple Inc.

MPEG4

This product is licensed under the MPEG-4 visual patent portfolio license for the personal and non-commercial use of a consumer for (i) encoding video in compliance with the MPEG-4 VISUAL standard ("MPEG-4 VIDEO") and/or (ii) decoding MPEG-4 video that was encoded by a consumer engaged in a personal or non-commercial activity and/or was obtained from a video provider license by MPEG LA to provide MPEG-4 video. No license is granted or shall be implied for any other use. Additional information including that relating to promotional, internal and commercial uses and licensing may be obtained from MPEG LA, LLC. See [HTTP://WWW.MPEGLA.COM](http://WWW.MPEGLA.COM).

All other nationally and internationally recognized trademarks and tradenames are hereby acknowledged.

© Copyright 2008 WowWee Group Ltd. All rights reserved.

Contents

Thank you for purchasing Rovio™ from WowWee™!	6
Package contents	7
Getting started	10
Battery and power requirements	10
Rovio	10
Charging dock and TrueTrack™ Beacon	10
Assembling the charging dock	10
Location	10
Assembling the charging dock	11
Disassembling the charging dock	12
Installing and charging the battery pack	13
Low battery	14
Installing the Rovio Setup software	15
PC users	15
For advanced PC users	16
Mac users	17
Rovio basics	21
Rovio charging dock	21
TrueTrack Beacons	22
Power switch LED light indicator	22
Rovio's interface	22
Overview of the Rovio interface	23
Using Rovio's interface	23
System requirements	23
Web browser supported features	23
Description of interface	24
Navigation controls	25
Camera controls	26
Camera capture control	26
Headlight control	26
Auxiliary controls	27
Indicators	29
Settings	30
Rovio online help	36

Video display contextual menu	36
Accessing the interface from your internal network	37
Setting up port forwarding	38
Using a domain name with Rovio	39
Creating, saving and playing back paths	41
Updating the Rovio firmware	43
Restoring Rovio to factory defaults	44
Caring for Rovio	45
Precautions	45
Safety	45
Use and handling	45
FAQs	46
Appendix A	48
Rovio browser and platform compatibility	48
Appendix B	49
Terminology	49
Index	50
Limited warranty	52

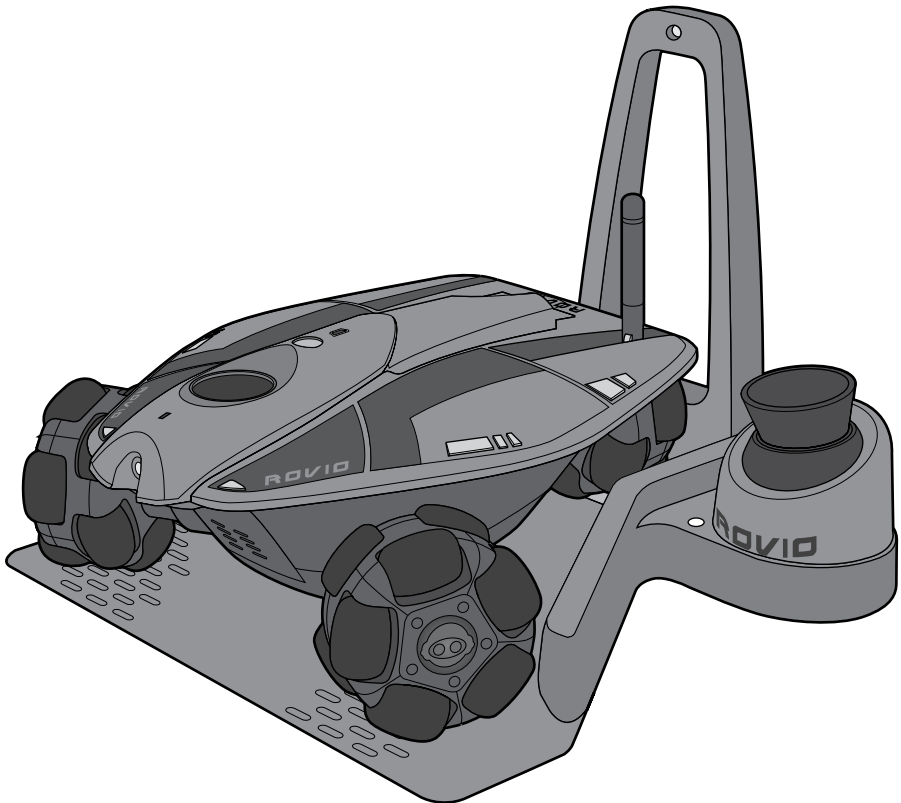

Thank you for purchasing Rovio™ from WowWee™!

With Rovio™, you will always be just a click away from the people and places that are important to you. Rovio is the Wi-Fi equipped mobile webcam that enables you to view and interact with its environment through streaming video and audio, wherever it is! Easily control Rovio remotely 24/7 from anywhere in the world! Use any web-equipped device: PC or Mac, cell phone, smartphone, PDA or even your video game console.

The TrueTrack™ Navigation System allows you to use the Rovio interface to store waypoints — with one click Rovio will automatically navigate itself to the chosen point. Rovio's built-in LED headlight will help you guide it even in dimly lit locations, so you'll always know what is going on at home or at the office. Rovio's self-docking function allows you to send Rovio back to the charging dock to recharge, with the click of a button on your browser!

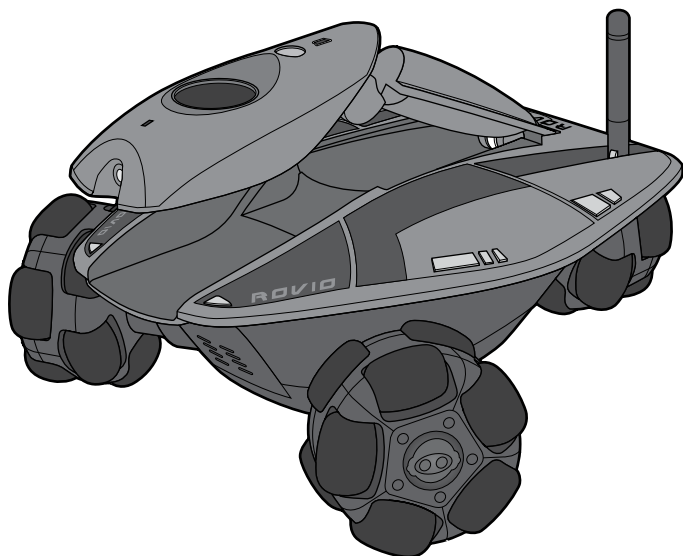

Package contents

This package contains the following:

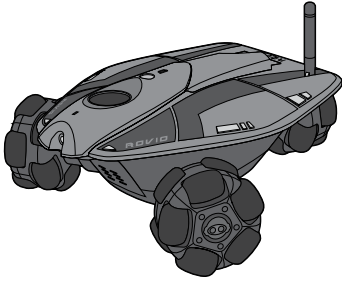

1 x Rovio™

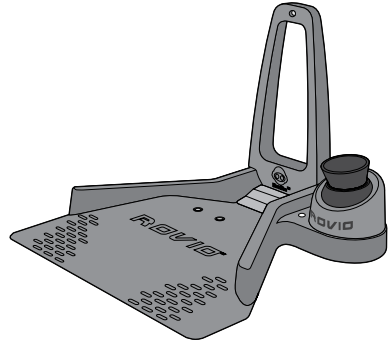

1 x Charging dock with built-in TrueTrack™ Beacon
1 x Mast

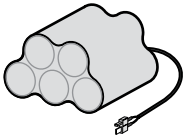

1 x 6 V 3000 mAH
NiMH rechargeable
battery pack



1 x Quick start
guide



1 x User manual

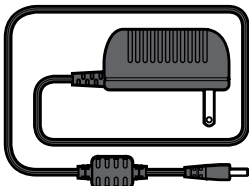

1 x 8 V AC/DC adapter



1 x USB cable



1 x Rovio Setup
CD

Quick overview

Rovio

Quick overview

Rovio

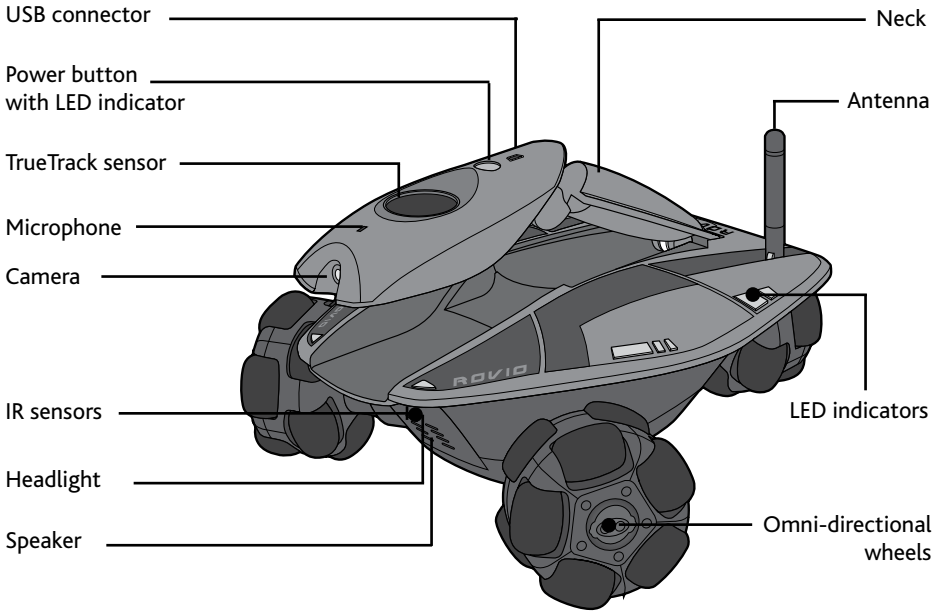

Underside of Rovio

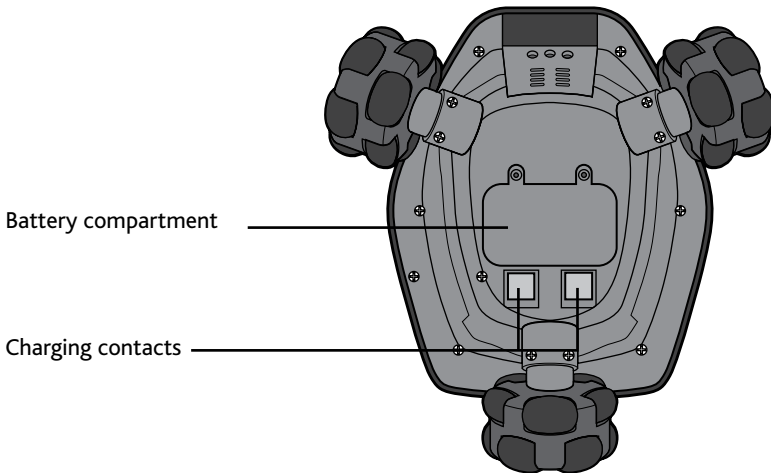

Charging dock

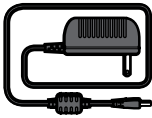
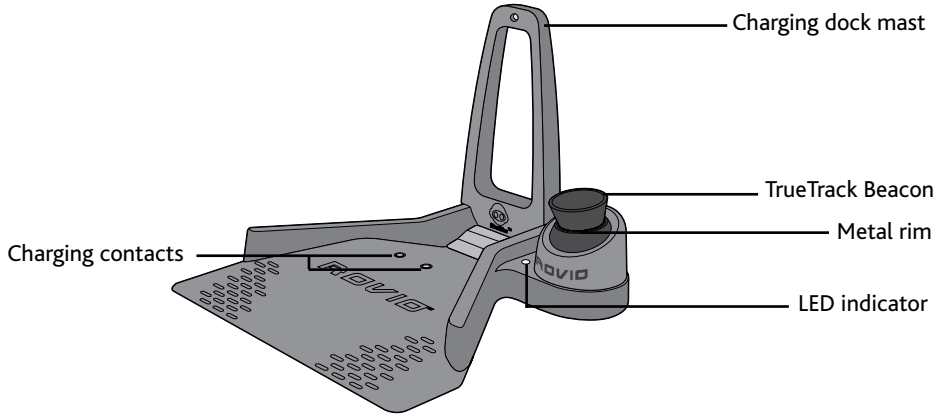

8V AC/DC adapter

Back view of charging dock

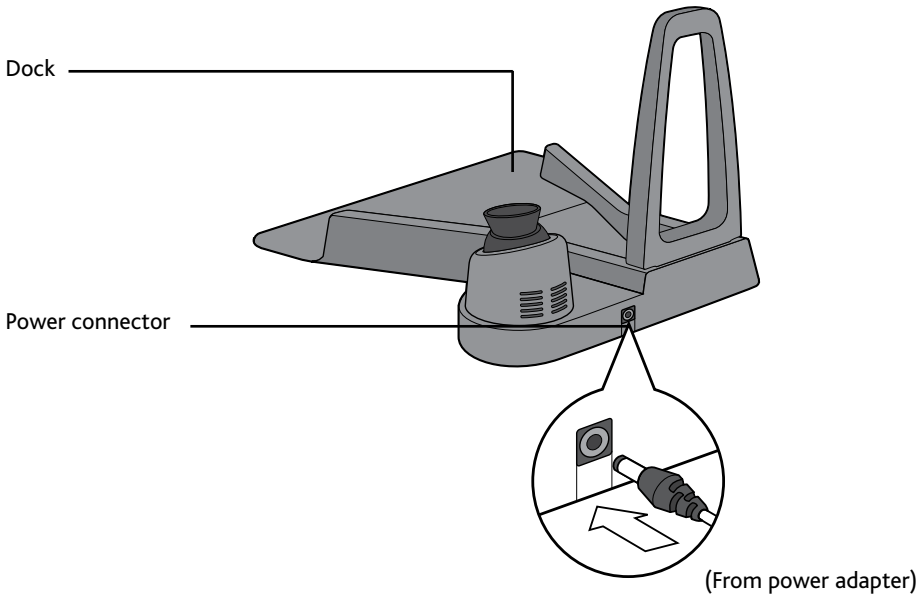

Getting started

This section describes how to get your Rovio up and running.

Battery and power requirements

This section describes the battery and power requirements for Rovio and its charging dock with built-in TrueTrack Beacon.

Rovio

Rovio uses a rechargeable 6 V NiMH battery pack (included).

Charging dock and TrueTrack™ Beacon

The charging dock with built-in TrueTrack™ Beacon requires power from an 8V AC/DC adapter.

Assembling the charging dock

When you first open the Rovio package the charging dock will be in two parts. You will need to put the parts together and then set up the built-in TrueTrack Beacon.

Location

In order for Rovio to accurately self-dock, the charging dock should ideally be placed where it will not be disturbed and preferably against a wall. Ideally, the room should have a flat ceiling no higher than about 10-12 feet (3-3.6 meters) with a clear space onto which the built-in TrueTrack Beacon can project its infrared beams. Air vents, large light panels or chandeliers, tall objects or furniture might prevent Rovio from detecting the signal that is projected onto the ceiling.

Important power adapter information

- Examine the AC/DC adapter regularly for damage to the cord, plug, enclosure and other parts.
- The AC/DC adapter is not a toy.
- Equipment liable to be cleaned with liquid are to be disconnected from the transformer before cleaning.

Assembling the charging dock

To assemble the charging dock:

1. Place the charging dock on the floor in the room you want to use as Rovio's home base.
2. Attach the mast to the charging dock by slotting it into position as illustrated.

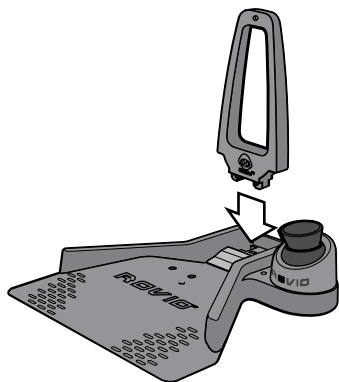

3. Plug the power cable into the port on the back of the charging dock and then plug the power adapter into the electrical outlet.

The LED indicator on the charging dock will light up, and the TrueTrack Beacon attached to the dock will light up red.

If the LED indicator on the base does not light up, it means that there is a problem with the connection between the mast and the base.

Unplug the power adapter, and detach the mast. To learn how, refer to the section *Disassembling the charging dock*. Next, reattach the mast and then reconnect the adapter.

If the Beacon is not lit, touch the metal rim on the Beacon and it will light up.

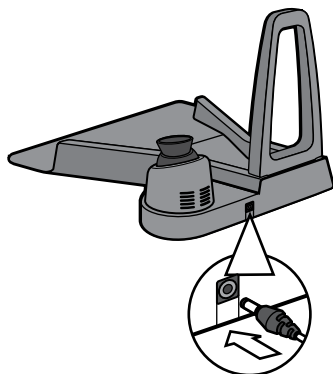

Getting started

Assembling the charging dock / Disassembling the charging dock

4. Two red dots will project light onto the ceiling. To optimize the signal, point the red dots at the center of the ceiling away from unsmooth surfaces such as lighting fixtures, fans, air vents and corners.

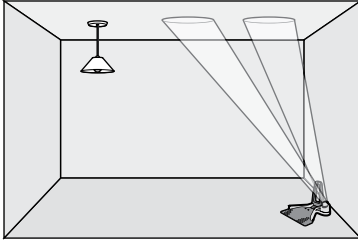

NOTES:

The red dots are a guide to help you set up the charging dock. If the light turns off while you are positioning the dots, touch the metal rim to reactivate it. During normal operation the red light will not be lit.

In order for Rovio to be able to self-dock and recharge, you must power the charging dock at all times.

Important battery information

- Use only fresh batteries of the required size and recommended type.
- Rechargeable batteries are only to be charged under adult supervision.
- Respect the correct polarity, (+) and (-).
- Do not throw batteries into the fire.
- The supply terminals are not to be short-circuited.
- Batteries should be replaced by adults.
- Remove batteries if the product is not going to be used for some time.
- This user manual should be kept because it contains important information.

Disassembling the charging dock

To disassemble the charging dock:

1. Unplug the power cable from the back of the charging dock and from the electrical outlet.
2. Turn the charging dock over and locate the two tabs that hold the mast in place. Using two fingers, squeeze both tabs towards each other and remove the mast

Installing and charging the battery pack

Before you use your Rovio, you need to install and charge the battery pack.

To install the batteries:

1. Locate and open the battery compartment door on the underside of Rovio.
2. Using a Phillips screwdriver (not included) loosen the two screws on the battery compartment door and remove it.
3. Locate and note the orientation of the battery connector and connect it to the battery. Insert and connect the battery according to the diagram in step 2.
4. Replace the battery compartment door and tighten the screws using the screwdriver. Do not over-tighten.

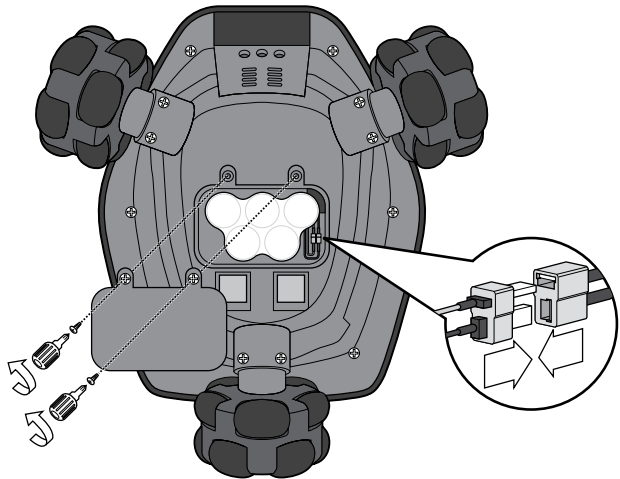

Getting started

Installing and charging the battery pack

To charge the batteries:

1. Ensure that the power to the electrical outlet is turned on and that Rovio is turned on by pressing the power button; Rovio's LEDs will light up.
2. Place Rovio in its assembled charging dock as illustrated.

The LEDs on Rovio will pulse quickly to indicate that it has begun charging.

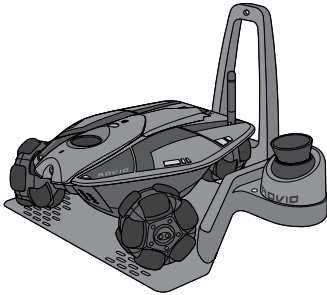

3. During charging, the LEDs on Rovio will pulse slowly; a single charge takes approximately two hours.

When Rovio has finished charging the LEDs will remain lit. It is safe to leave Rovio on its charging dock after the charge has completed.

Low battery

When Rovio's batteries begin to run low, it will warn you with the following:

- Rovio interface warning message.
- Power switch LED light indicator flashes green, orange or red (refer to the section *Power switch LED light indicator*).

If Rovio is in the same room as its charging dock and the interface indicates that it has a navigation signal, it will automatically try to return to the charging dock when its batteries are running low after you click on the low battery warning message.

Otherwise, you can send it back to its charging dock by clicking on the **Home**  button on the interface. Refer to the *Auxiliary controls* table in the *Description of interface* section for details.

If you ignore the request to drive Rovio back to its charging dock and continue to use it, Rovio will shut off automatically when its batteries are drained, and you might not be able to drive it back to the charging dock to recharge.

NOTE: Rovio must detect the charging base before it can navigate home.

Configuring your Rovio the first time

Before you use Rovio for the first time, you will need to configure your Rovio.

To install the Rovio Setup software, your computer set-up must have the following:

- Windows XP™ or Window Vista™
- USB connectivity
- Wireless access point (WAP) device (for example, your wireless router)
- A CD/DVD drive
- A Wi-Fi card (for Ad hoc setup)

NOTE: If you are a Mac user, refer to the subsection *Mac users* in the section *Installing the Rovio Setup software* to learn how to configure Rovio without the Rovio Setup CD.

IMPORTANT: Rovio does not support WPA passwords on wireless access points; it only supports WEP passwords. For instance, if your wireless router uses a WPA password, you will need to change it to a WEP password. Refer to your router's user manual.

Please go to www.wowweesupport.com to check if a firmware update supporting WPA has become available.

Installing the Rovio Setup software

This section describes setting up Rovio on PC and Mac computers.

PC users

NOTE: To run the Rovio Setup CD, you need a PC computer running Windows XP™ or Windows Vista™ equipped with a CD drive.

To run the Rovio Setup:

1. Verify that your wireless router is turned on and working. Also ensure that Rovio is fully-charged and ON.
2. Insert the **Rovio Setup CD** in your CD drive on your computer.

Configuring your Rovio the first time

Installing the Rovio Setup software

3. If Autoplay is enabled on your computer, the **Rovio Setup installation** dialog will appear. If it does not, locate the **RovioSetup.exe** file on the CD and click on it to begin installation.

The **Rovio Setup** wizard will appear.



4. Follow the onscreen instructions for installing the Rovio Setup software.

NOTE: If you are using the Rovio Setup CD, you should not turn Rovio on while it is connected to your computer via USB.

For advanced PC users

You can install the Rovio Setup software without the **Rovio Setup CD** (Ad hoc mode). Note that you need a WiFi card on your PC. To do so:

NOTE: These instructions for advanced PC users can only be used to first configure Rovio or after you restore it to its default factory settings.

1. Ensure that Rovio is fully-charged and ON.
2. From your Windows Control Panel, select **Network Connection** or **Network and Sharing Center** (Windows Vista), and then click on the option to create a new connection.
3. Follow the onscreen instructions to create an advanced connection, that is, you want to connect directly to another computer.
4. Connect to the **ROVIO_WOWWEE** network (Rovio's default SSID).
5. In the **Local Area Connection Properties** dialog, select the **TCP/IP** option, and then click on **Properties**.

The **TCP/IP Properties** option appears.

6. Select the option **Use the following IP address** and enter the following information:

IP address	192.168.10.5
Subnet mask	255.255.255.0
Default gateway	Leave blank

7. Once your Ad hoc connection is established, you can interface directly with Rovio to change its settings from the **Settings** button (refer to the *Settings* subsection in the *Description of interface* section). Enter **http://192.168.10.18** in the address bar of your Internet browser.

Your Rovio is now configured to work on your internal network.

NOTES:

Once configured on your internal network, or if you have changed Rovio's settings, you can reset Rovio to Ad hoc mode via its interface.

You can configure Rovio to be accessible from an external network; follow the links in the setup wizard for further details, refer to the WowWee Support site (www.wowweesupport.com), or refer to the section *Using Rovio from an external network*.

Mac users

If you are running a Mac you will need to configure your Rovio without the Rovio Setup CD.

NOTE: You need to be logged in with administrative privileges.

To do so:

1. Verify that your AirPort is on and connected to your wireless router (this should also be turned on and working). Ensure that Rovio is fully charged and ON.



Configuring your Rovio the first time

Mac users

2. Note your current Wi-Fi settings.
 - a. From the **Apple** menu, select **System Preferences**.
 - b. Select the **Network** option and then select **AirPort** located in the **Network Status** pane.
 - c. Click on the **Advanced** button, and then select the **TCP/IP** tab. Note all the network settings that appear, as you will need them throughout the configuration.
3. You need to verify the IP address that you will use for Rovio. From the Finder select **Applications**, then **Utilities**, then select **Terminal**.

- a. Type **ping -c2** and then type the first three sets of numbers from the IP address you noted in step 2c (e.g. **ping -c2 210.172.15**)

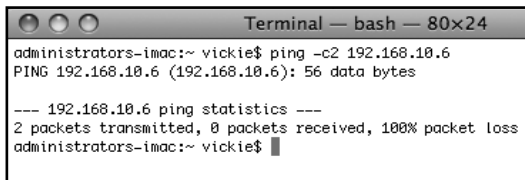

```
Terminal — bash — 80x24
administrators-imac:~ vickie$ ping -c2 192.168.10.6
PING 192.168.10.6 (192.168.10.6): 56 data bytes

--- 192.168.10.6 ping statistics ---
2 packets transmitted, 0 packets received, 100% packet loss
administrators-imac:~ vickie$
```

followed by 6 (e.g. **ping -c2 210.172.15.6**) and press **Enter**.

- b. If the application returns with a data message containing **0 packets received**, note the IP address and continue to step 4.

- c. If the application returns with **1 packet received** or **2 packets received** the IP address is not available. To try a different IP address, repeat step 3a adding 1 to the final digit (e.g. **ping -c2 210.172.15.7**).

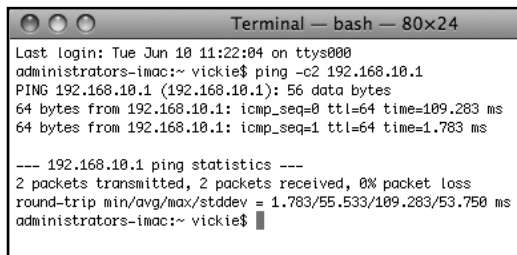

```
Terminal — bash — 80x24
Last login: Tue Jun 10 11:22:04 on ttys000
administrators-imac:~ vickie$ ping -c2 192.168.10.1
PING 192.168.10.1 (192.168.10.1): 56 data bytes
64 bytes from 192.168.10.1: icmp_seq=0 ttl=64 time=109.283 ms
64 bytes from 192.168.10.1: icmp_seq=1 ttl=64 time=1.783 ms

--- 192.168.10.1 ping statistics ---
2 packets transmitted, 2 packets received, 0% packet loss
round-trip min/avg/max/stddev = 1.783/55.533/109.283/53.750 ms
administrators-imac:~ vickie$
```

Continue to add 1 to the final figure until you receive the data message **0 packets received**. Note the IP address.

4. You need to connect directly to your Rovio (Ad hoc connection). Click on **AirPort** in the menu bar on top of the screen. Select the **ROVIO_WOWWEE** network (your Rovio).
5. You now need to adjust the TCP/IP settings for your computer to work with Rovio. To do so:
 - a. From the Apple menu, select **System Preferences**.
 - b. Select the **Network** option and then select **AirPort** located in the **Network Status** pane.
 - c. Click on the **Advanced** button, and then select the **TCP/IP** tab.

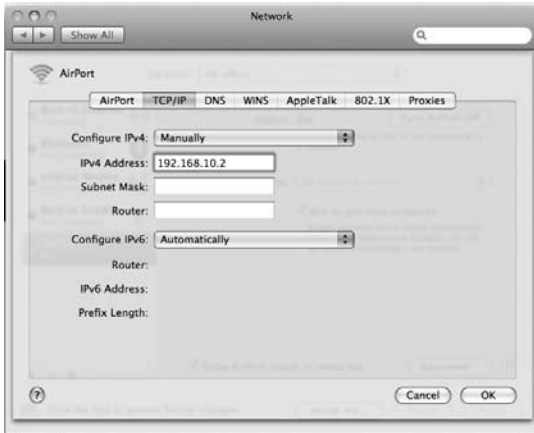

- d. From the **Configure IP** options, change the setting to **Manually**.
 - e. In the **IP Address** field, enter **192.168.10.2** and then click on **OK**. This will be the IP address of your computer.
6. In the address bar of your preferred web browser, enter **http://192.168.10.18**; this is default the IP address for your Rovio. You should now be able to view the Rovio interface.

If you do not see Rovio's interface, try resetting your Rovio by turning it OFF and then ON again. Wait until the LED on the power button turns from orange to green and then refresh the web browser.

Configuring your Rovio the first time

Mac users

7. Now you will configure Rovio's network settings to work with your router. In the Rovio interface, click on the **Settings** button located at the top right. Select the **Network** tab.

8. In the **SSID** field, type in the name of your wireless network (i.e. your router).

9. Change the mode to **Infrastructure**.

10. Next, if you use a wireless network password, you will need to enter it.

Select the type of **Encryption** (e.g. WEP 64) and then select the type of **Key** (e.g. ASCII). Enter the router's password in the field.

11. In the **IP Setup** section select **Manually**

12. In the **IP address** field, enter the IP address you noted down at step 3.

13. Using the settings you noted at step 2c, enter the **Subnet mask**, **Default gateway** (this is your router's IP) and **DNS** (if any) information, and then click on **Update**.

14. You now need to connect to your wireless network. From the **System Preferences** item of your Apple menu, select **Network**, then **AirPort**, and then re-enter the settings details you noted at step 2c for your wireless network.

Your Rovio is now connected to your internal wireless network.

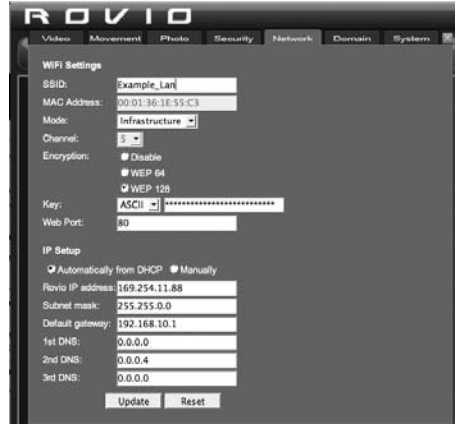

15. In the address bar of your web browser, enter in the IP address you entered in the Rovio settings from step 11 (e.g. **210.172.15.7**). You can now control your Rovio using its interface.

NOTE: If you want to set a password for your Rovio, turn the security settings on or off, or add a new user, click on the **Settings** button in the Rovio interface, and then select the **Security** tab. Enter the information for a new user.

Uninstalling the Rovio Setup software

To uninstall the Rovio Setup software (Windows users only):

- From Program Files, locate the WowWee/Rovio directory, and then select **Uninstall**. Follow the onscreen instructions to uninstall the software.

Rovio basics

Rovio charging dock

The charging dock is used as Rovio's home base where it can recharge and be stored when it is not being used. Using Rovio's interface, you can click on the **Home** button and Rovio will automatically navigate itself back to the charging dock to recharge.

NOTE: You need to set the home position before you can use the send home function.

To set the home position:

1. Place Rovio in its charging dock.
2. Click on the **Save Home** button . Rovio will drive away from the charging dock, record the home position, and then automatically dock itself in the charging dock

NOTES:

Ensure that Rovio's neck is down (i.e. horizontal) while you save its home position.

Rovio will automatically lower its neck when returning to its charging dock while self-docking.

TrueTrack Beacons

Rovio uses TrueTrack Beacons to help it locate its charging dock (home base). The charging dock comes with a built-in TrueTrack Beacon. The Beacon projects two IR signals on the ceiling that Rovio uses as its guiding lights to track the location of the Beacon.

To extend Rovio's navigation distance, you can install additional TrueTrack Room Beacons (sold separately) to help it locate additional rooms to which you want Rovio to navigate.

Power switch LED light indicator

The following table describes the power switch LED light indicator colors:

Power switch light color	Description
Green	Network connection is functioning properly.
Green (blinking)	Low battery. Network connection is functioning properly.
Orange	Rovio is booting and/or trying to connect to a network.
Orange (blinking)	Low battery. Rovio is booting and/or trying to connect to a network.
Red	Network connection is functioning properly and Rovio is being accessed.
Red (blinking)	Low battery. Network connection is functioning properly and Rovio is being accessed.

Rovio's interface

Rovio's interface is entirely browser-based, which means you can access Rovio via the Internet using any web-enabled device. Refer to the section *Overview of Rovio interface* for more details.

Overview of the Rovio interface

This section describes Rovio's user interface.

Using Rovio's interface

To control Rovio you must have a web-enabled device.

System requirements

Your web-enabled device must meet the following system requirements:

- Device running one of the following browsers:
 - Internet Explorer 6 or higher*, or
 - Mozilla Firefox 1.5 or higher, or
 - Safari 3.0, or
 - Mobile Safari, or
 - Internet Explorer Mobile, or
 - Opera Mobile.
- Wireless access point (WAP) device connected to your PC (for example, a wireless router)
- High-speed Internet connection

*Internet Explorer 6 or higher required for two-way audio feature.

Web browser supported features

The following table describes Rovio's supported features according to the web browser.

Browser	Video	Audio
Internet Explorer (6.0 and up)	MPEG4	Mono, 8-bit
Mozilla Firefox (1.5 and up)	M-JPEG (motion JPEG)	Not available
Safari	M-JPEG (motion JPEG)	Not available
Opera	M-JPEG (motion JPEG)	Not available

For a more complete list of browser features, refer to *Appendix A*.

Overview of Rovio's interface

Description of interface

Description of interface

This section outlines the main controls in the Rovio user interface.







1. Navigation controls
2. Camera position controls
3. Camera capture control
4. Headlight control
5. Auxiliary controls
6. Indicators
7. Settings
8. Video display pane
9. Rovio online help

The following tables outline the main controls in the Rovio user interface.

NOTE: Depending on the web browser you use, some of these options might not be available.



Navigation controls

Command	Description
Rotation buttons	Allows you to rotate Rovio on the spot in increments.
	Rotate Rovio counter-clockwise. Click on the button and hold for continuous turning.
	Rotate Rovio clockwise. Click on the button and hold for continuous turning.
	Rotate Rovio a set number of degrees relative to its current position: around 45, 90, 135, 180 degrees clockwise or counter-clockwise.
Direction arrows 	Directs Rovio left (left arrow), right (right arrow), forward (up arrow) and backward (down arrow). You can also use the following keyboard buttons to direct Rovio: a or left keyboard arrow (strafe left), d or right keyboard arrow (strafe right), w or up keyboard arrow (forwards), s or back keyboard arrow (backwards), q (turn left), e (turn right), Space bar (to stop driving autonomously), -/+ (to toggle speeds).
Joystick pad 	Moves Rovio in the direction in which you drag the Rovio icon on the joystick pad.

Overview of Rovio's interface

Camera controls, Camera capture control, Headlight control

Camera controls

Command	Description
Camera position low 	Positions the neck at the lowest position. You can also use the keyboard button 1.
Camera position mid-way 	Positions the neck mid-way. You can also use the keyboard button 2.
Camera position high 	Positions the neck at full height. You can also use the keyboard button 3.



Camera capture control

Command	Description
Camera 	Allows you to take a still photo screen capture and send it to a specified email address. NOTE: To send the screen capture to a specified email, you need to first configure the screen capture settings. Refer to the description of the Photo tab in the <i>Settings</i> section.

Headlight control

Command	Description
Headlight 	Toggles Rovio's headlight.

Auxiliary controls





Command		Description
Paths tab		<p>Allows you to set path of way points to which Rovio will navigate.</p> <p>Refer to the section <i>Creating and saving paths</i> for more details.</p>
	Record/Save	<p>Records a path and then saves it to Rovio's memory using a path name.</p> <p>When you record a path, all commands are recorded including head positions, photo, and headlight commands..</p>
	Delete	Deletes the selected path.
	Reset All	Deletes all paths.
	Stop	Stops Rovio's driving while moving along the current path.
	Save Home 	Saves the current location as Rovio's home position (home base).
Home 	<p>Send Rovio back to charging dock. Note that you need to first set the home position (home base).</p> <p>You can also use the keyboard button H for this function</p> <p>NOTE: Rovio must be able to detect its charging dock (i.e. Room 0) in order to navigate home..</p>	
Visual Tab		<p>Allows you to toggle the speed and quality of the streaming video.</p> <p>Use the slider to adjust the video quality. Move the slider to the left to decrease the video quality, that is, stream faster video (less frames/second and lower resolution); move the slider to the right to increase the video frame rate and resolution.</p>

Overview of Rovio's interface

Auxiliary controls

Command		Description
	Video priority slider	Adjusts Rovio's video quality by adjusting video frame rate and quality. Move the slider to the left to lower the frame rate and quality; move the slider towards the right to increase the frame rate and quality.
	Video brightness slider	Adjusts the brightness of the video stream from Rovio. Move the slider to the left to lower the brightness; move the slider towards the right to increase brightness.
	Maintain Ratio	Enable this option to maintain the aspect ratio of the video stream when it is resized. This option is enabled by default.
Audio tab		Allows you to adjust Rovio's output audio levels. NOTE: Depending on the web browser you use, some of these options might not be available.
	Rovio's Speaker Volume	Use the slider to adjust Rovio's speaker level. Move the slider to the left to lower the output level; move the slider towards the right to increase the output level.
	Rovio's Mic Volume	Use the slider to adjust Rovio's microphone levels. Move the slider to the left to lower the microphone input levels; move the slider towards the right to increase the microphone input levels.

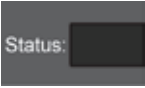
Indicators

Indicator	Description
Nav 	Indicates the strength of the navigation signal received from the charging dock or a TrueTrack Room Beacon. Full bars indicate a strong signal.
0-9	Indicates the room ID number assigned to a room, as set on the TrueTrack Room Beacon (sold separately). 0 is always assigned to the charging dock. Note that the room ID numbers only appear when the Beacon is in range.
Battery 	Indicates the strength of Rovio's battery. Full bars indicate a fully charged battery.
Status 	Indicates Rovio's current driving status. Options: Roaming, Saving Home, Home Saved, Going Home, Docked, Recording Path, Following a [name of a path], Low navigation signal, No navigation signal.
Wi-Fi 	Indicates the strength of the wireless Internet connection (Wi-Fi signal). Full bars indicate a strong signal.

Overview of Rovio's interface

Settings (Video and Movement tab)

Settings

This button allows you to specify various settings for Rovio including video preferences, router information and security settings.

NOTE: Changes in the **Settings** menu are not recordable.

Command		Description
Video tab		Allows you to adjust video settings.
	Resolution	Set the video resolution to the required size (in pixels). Options: 176x144, 320x240, 352x288 (default), 640x480
	Quality	Set the quality of the video stream. Options: Low, Medium (default), High
	Frame Rate	Set the video frame rate (fps). Options: 1 to 30 frames per second (fps). Default is 30 fps.
	Brightness	Adjust the brightness of the video stream. Move the slider to the left to decrease the brightness; move the slider to the right to increase brightness.
Movement tab		Allows you adjust movement settings
	Movement speed	Adjust the speed of Rovio's movements. Move the slider to the left to decrease the speed of the movement; move the slider to the right to increase speed of the movement.

Overview of Rovio's interface

Settings (Movement and Photo tab)

Command		Description
	Turn speed	Adjust the speed of Rovio's turning movements. Move the slider to the left to decrease the turning speed; move the slider to the right to increase turning speed.
	Angle Turn Speed	Adjust the speed of Rovio's turning angle. Move the slider to the left to decrease the speed of the turning angle; move the slider to the right to increase the speed of the turning angle.
	IR Radar	Toggles Rovio's obstacle detection feature. When enabled, Rovio's viewing area lights up light blue on the joystick pad. When it is playing back a path and detects an obstacle, a flashing block appears at the top of the joystick pad and Rovio will stop moving towards the object and attempt to find a path around the obstacle. NOTE: When you manually drive Rovio, it can only detect obstacles as it approaches them, but not avoid them.
Photo tab		Specify settings for emailing screen captures from Rovio's interface.
	Enable Email Photo	Toggles the screen capture emailing function. Enable the option to allow the screen capture emailing function.
	SMTP settings	Specify an SMTP server. Refer to your email client settings for reference.
	SMTP Port	Specifies the port to use for your SMTP server. Default is 25.
	Username	Enter the username you use for your mail server, if required..

Overview of Rovio's interface

Settings (Photo and Security tab)

Command		Description
	Password	Enter the password you use for your mail server, if required..
	Confirm Password	Enter the same password you use in the Password field, if required..
	Email Settings	Specify email settings to which you send video screen captures.
	Sender Email Address	Specify an email address from which to send video screen captures.
	Receiver Email Address	Specify a destination email address to which to email video screen captures.
	Email Subject	Specify a subject line for your video screen capture email.
	Email body	Enter the text you want to appear in the body of the email you want for your video screen capture email.
Security tab.		Allows you to adjust security settings
	Enable User Authentication	Toggles the user authentication option. Click on the Update button to save the setting.
User Accounts		
New User		
	Username	Create a username for a new user on your Rovio.
	Password	Create a password for the user being created for your Rovio.
	Confirm	Enter the same password you entered in the password field.
	Admin Access	Allows you to create and manage accounts for administrative use. Also allows user access permission settings.
	Add User	Click to add additional new users.

Overview of Rovio's interface

Settings (Network tabs)

Command		Description	
Network tab		Allows you to specify network options and settings	
	Wi-Fi Settings	Specify the wireless connection settings.	
	SSID	Specify the name of the wireless router (SSID) you will use with Rovio. Also, in Ad hoc mode, it indicates the name of the Ad hoc network to which you are connected. Refer to your router settings for reference.	
	MAC Address	Specify the MAC address of Rovio.	
	Mode	Specify an Infrastructure or Ad hoc mode of networking. Default is Ad hoc.	
	Channel	Selects a Wi-Fi channel on the router used to communicate with Rovio (used for Ad hoc mode). Note: No router is used in Ad hoc mode.	
	Encryption	Specify the type of encryption used for your router.	
		Disable	No encryption used.
		WEP 64	Use the 64-bit encryption key used for your router. Refer to your router settings for reference.
		WEP 128	Use the 128-bit encryption key used for your router. Refer to your router settings for reference.
	Key	Specify a password key (WEP key) used on your router (in ASCII or HEX).	
Web Port	Specify a communication channel on the router on which to use Rovio. Default channel is 80.		

Overview of Rovio's interface

Settings (Network tab)

Command		Description
	IP Setup	Allows you specify IP settings for your Rovio and router.
	Automatically from DHCP	<p>Automatically select an IP address based on the router's DHCP settings.</p> <p>Select this option if you do not want to specify an IP address.</p> <p>NOTE: Selecting this option disables the options for manually setting Rovio's IP address (i.e. Rovio IP address, Subnet mask, Default gateway, and DNS options).</p>
	Manually	Specify an explicit IP address for your Rovio.
	Rovio IP address	Specify an IP address for Rovio.
	Subnet mask	<p>Specify a range of addresses to use with Rovio.</p> <p>Use 255.255.255.0 if you do not have a specific subnet mask.</p>
	Default gateway	<p>Specify a default network node (gateway) to use with Rovio.</p> <p>The default gateway address should be the IP address of your router.</p>
	DNS	<p>Specify the DNS server. Used to resolve DNS names to IP addresses for DNS names.</p> <p>Refer to your router's settings for reference.</p>
	Update	Save all settings specified on this tab.
	Reset	Erase all settings on this tab.

Overview of Rovio's interface

Settings (Network tab)

Command	Description
Domain tab	Allows you to specify a dynamic domain name system. Refer to section <i>Using a domain name with Rovio</i> for more information.
Enable	Toggle whether you want to use a dynamic domain name system to access Rovio.
Server	Specifies the server.
Domain	Specifies the domain name.
Username	Specifies the username for your account.
Password	Specifies the password for your account.
Confirm	Enter the password from the Password field.
Overwrite IP	Allows you to overwrite and specify the IP address that is sent to your dynamic DNS server.
Proxy Settings (optional)	Allows you to specify settings for a proxy server, if you use one.
Server	Specifies the server..
Port	Specifies the port to use..
Username	Specifies the username for your account.
Password	Specifies the password for your account.
Update	Saves all settings specified on this tab.
Reset	Erases all settings on this tab.
Check Status	Allows you to verify Rovio's status and its connection with your DNS server.

Overview of Rovio's interface

Settings (System tab), Rovio online help, Video display contextual menu

Command		Description
System tab		Allows you to reboot Rovio, restore system defaults, and update Rovio's firmware.
	Reboot system	Click on the Reboot button to reboot Rovio.
	Restore Default Settings	Click on the Restore button to restore default settings to Rovio.
	Update Firmware Image	Allows you to update the Rovio firmware. Refer to <i>Updating the Rovio firmware</i> for more information.

Rovio online help

Command	Description
Help	Accesses contextual help for the Rovio interface. Click on the Help button to access.

Video display contextual menu

The table below outlines the options available in the contextual menu (right-click) for the video display window.

NOTE: This contextual menu is only available for Internet Explorer on a PC platform.

Command	Description
Quality	Allows you to toggle the quality of the video stream.
	Low Low image quality video stream.
	Medium High image quality video stream.
	High Highest image quality video stream.
Resolution	Allows you to adjust the resolution of the video stream, in pixels. 176 x 144, 320 x 240, 352 x 288, 640 x 480

Accessing the interface from your internal network

Command	Description
Save Current Image As	Allows you to save screen capture in JPEG format. To save the screen capture, select this option, then name and save the file to your computer.
Start/Stop Mic	Toggle the microphone on your computer. NOTES: This option only available on Internet Explorer on a PC (i.e. supports two-way audio streams). You should avoid using your computer microphone in the same room as Rovio as it will create audio feedback.

Accessing the interface from your internal network

To access Rovio's interface:

- In address bar of your browser window, enter the IP address of your Rovio (e.g. **192.168.10.18**).

NOTE: If you do not have the required ActiveX component installed in your Internet Explorer browser, you will be prompted to install it when you access Rovio's interface (otherwise you will not be able to view the streaming video). When prompted, install the required ActiveX.

To be able to access Rovio's interface from outside your internal network, you will need to set up port forwarding. Refer to the section, *Using Rovio from an external network*.

Using Rovio from an external network

Setting up port forwarding

Using Rovio from an external network

To be able to use Rovio outside your internal network, you will need to set up port forwarding on your wireless router to be able to communicate with Rovio.

Setting up port forwarding

To be able to access Rovio over the internet from any internet access point, you will need to open up the required ports on your router (port forwarding).

Refer to your router's user manual on how to set up port forwarding. If you do not have a user manual for your router, you will need to refer to external sources to set up your router for port forwarding.

To do so:

1. Determine and note the make and model of your wireless router.
2. Refer to the WowWee Support site (www.wowweesupport.com) for information on locating port forwarding information for your router. You will need this information to set the port forwarding details in Rovio's settings.

For Rovio, you will need to open up 2 ports: port 80 and port 554. Port 80 is for the M-JPEG stream and control over the Rovio; port 554 is for the MPEG4 and audio stream.

Configure your ports with the following options:

	Port 80	Port 554
Protocol	TCP	TCP
External TCP/IP Port	80	554
IP Address	[Rovio's internal IP address]*	[Rovio's internal IP address]*
Internal TCP/IP Port	80	554

*Refer to the description of the Network tab in the section *Overview of Rovio's interface* to determine your Rovio's internal IP adress.

4. Save your router's port forwarding settings.
5. Test your configuration using a computer or other web-enabled device outside your internal network. You can also test your Rovio using port forwarding tools. Refer to the WowWee Support site for more details.

Your Rovio is now set up for access outside your internal network.

NOTE: Some Internet service providers do not allow for outbound traffic on port 80, in which case you might need to choose another port (other than 80) that is open for outbound traffic, for example, 8080. To do so, access Rovio's network settings, enter the new port number in the **Web Port** field and then save your changes. In this case, to access Rovio, you will need to enter the full web address including the port number, for example **http://192.168.10.18:8080**.

Using a domain name with Rovio

Once you have your external port forwarding configured, you can use a dynamic domain name system (DNS) with your Rovio, for instance **abc.myrovio.com**.

If you have previously registered a domain name you want to use with Rovio, you can configure Rovio to use the domain name instead of an IP address.

If you do not have a domain name previously registered, you can do so from a number of dynamic DNS service providers.

Using a domain name with Rovio

Once your ports are set up for forwarding, you can log onto Rovio to set up your domain name. To set up your domain name to be used with Rovio:

1. From the Rovio interface, select **Settings**, then select the **Domain** tab.
2. On the **Domain** tab, enable the **Enable** option.
3. Enter the server information for your domain in the **Server** field.
4. Enter the domain name information for your domain in the **Domain** field (for example, **abc.myrovio.com**).
5. Enter the user name for your account in the **Username** field.
6. Enter the password for your account in the **Password** field.

If you use a proxy server (optional), you can enter the information in the **Proxy Settings** area.

7. Click on **Update** to save your settings.

Your Rovio is now configured to use your registered domain name. You can now enter your domain name in the address bar of your browser to access Rovio.

NOTES:

If you created a login and password for Rovio, you will be prompted to enter this information when you access it.

If you used a port other than 80 for outbound traffic (see the section *Using Rovio from an external network*), you will need to use the port number in your web address.

Creating, saving and playing back paths

You can create up to ten paths for Rovio to remember and play back. A path can be made up of several actions in any order, including:

- A route that Rovio drives
- Moving the camera position
- Taking and emailing a photo

To create a path:

1. On the **Paths** tab in the Rovio interface, click on the **Record** button to begin recording your path.
2. Drive your Rovio to the location you want the path go to.
3. Click on the **Save Path** button to stop recording and save the path. You will be prompted to name the path (default name is **New Path**). The path will be saved in Rovio's memory.
4. Repeat for any other paths you want to create.

NOTES:

Do not click **Stop** while recording a path. This will reset the record function and Rovio will not save the path.

For large areas, multiple rooms, and/or areas with many walls, you should set up multiple TrueTrack Room Beacons (sold separately).

To rename a path, click on the path from the list and then edit the name.

To play back a path:

- On the **Paths** tab in the Rovio interface, double-click on the name of the path you want to play. When it has played back the path, it will await a new command.



Using Rovio with VoIP applications

To delete a path:

1. On the **Paths** tab in the Rovio interface, select the name of the path you want to delete.
2. Click on the **Delete** button to delete the path.

Using Rovio with VoIP applications

You can use Rovio as your mobile webcam with VoIP applications in Windows® XP™ or Windows® Vista on PC platforms (such as Skype™ or Windows Live Messenger Call) after you install the Rovio Setup software; this allows you to use Rovio for streaming video. You first need to configure your application to use Rovio as your webcam in video chats.

NOTE: When you use Rovio for your VoIP webcam, there is no audio stream. In this case, for audio, you should use a separate computer microphone (not included).

To do so:

1. Locate the video settings options in your VoIP application.
2. Select **Rovio IP Camera** as your default camera and then confirm your selection.
3. Locate the camera properties dialog in the VoIP application. Enter your the IP address of the Rovio you want to use. You will also need to enter your username and password, if security is enabled, and then click on **OK**.

You should test and preview the camera's video stream; most VoIP applications allow you to preview the video using the application's interface.

You can now use Rovio as your webcam when you have video chats with your contacts.

For any updates to the Rovio VoIP application plugins, refer to the Rovio site (www.myrovio.com) or to the WowWee Support site (www.wowweesupport.com).

NOTE: There is no audio support for third party applications. Refer to the product support or WowWee Support sites for more information.

Updating the Rovio firmware

When firmware updates are available, you can download them and update the Rovio.

NOTES:

Ensure that Rovio is on and connected to your network. Also make sure that Rovio has enough battery power before updating it.

All your settings will be overwritten when you update the firmware image. You will need to manually reconfigure them after updating firmware.

IMPORTANT: Do not unplug Rovio from your computer (if plugged to the computer) nor turn it off while the firmware is being updated. Ensure Rovio is on. To update the Rovio firmware image:

1. From the Rovio product site (www.myrovio.com) or the WowWee Support site (www.wowweesupport.com), locate the link for the latest Rovio firmware image and download it to your computer.
2. Make sure Rovio is ON. In the Rovio interface, click the **Settings** button.
3. In the **System** tab, locate the **Select Firmware Image** field, and click on the **Browse** button. A **Choose file** dialog appears.
4. Locate the Rovio firmware image file you downloaded (***.bin**) and then click on **Open**.
5. Click on **Update** to update the firmware image. Wait for Rovio to reboot.

Your Rovio should be updated with the latest firmware. You can verify the version number of the firmware in Rovio's interface (located on the **System** tab of the **Settings** menu).

IMPORTANT: Do not turn off Rovio until it has finished updating. The update will not take effect until you reboot Rovio. Ensure you have a full battery so that it does not lose power during the update.

You can also restore Rovio's default firmware using the Rovio Restore wizard. Refer to the section *Restoring Rovio to factory defaults* for more information.

Restoring Rovio to factory defaults

You can restore Rovio to its factory defaults, including its firmware, using the Rovio interface or the Rovio Restore wizard (using a PC), for instance, if you need to change the security settings.

To do so:

- From the **Program Files** directory, locate and run the **Rovio Restore wizard** (on a PC) and then follow the onscreen instructions.

OR

1. In the Rovio interface, click on the **Settings** button.
2. Select the **System** tab.
3. Click on the **Restore defaults** button.

Rovio will be restored to the original factory settings.

You can then run the Rovio Setup wizard again to reconfigure Rovio.

Caring for Rovio

This section outlines various precautions, instructions and warnings on caring for Rovio.

Precautions

Before using this product, read this user manual and retain it for future reference.

Safety

This product has been designed with the highest concern for safety. However, note that any electrical device if used improperly has the potential of causing fire, electrical shock or personal injury. To help ensure accident-free operation, you should follow the guidelines outlined below:

- Observe all warnings, precautions, and instructions.
- If the device functions in an abnormal manner, produces unusual sounds or odors, or if it becomes hot to the touch, stop use, unplug the AC adapter (if used) from the electrical outlet, and disconnect any other cables to the object immediately.

Use and handling

- Do not use Rovio near water.
- Do not immerse Rovio or any parts of it in water.
- Do not expose Rovio to high temperatures, high humidity, or direct sunlight.
- Do not expose Rovio to dust, smoke or steam.
- Do not allow liquid or small particles to get into Rovio.
- Do not place Rovio on surfaces that are unstable or subject to vibrations.
- Do not throw or drop Rovio, or subject Rovio to strong physical shock.
- Do not place Rovio close to items with a magnetic strip, such as a credit card.
- Do not touch the TrueTrack sensors.
- Avoid touching the camera lens as much as possible.
- When required, gently clean the camera lens surface with a soft, non-abrasive cloth.
- Never manually force Rovio's neck up or down.

FAQs

This section lists frequently asked questions about Rovio.

Q: *I clicked on the Home button, but Rovio can't seem to find its charging dock properly. What's wrong?*

A: There are number of reasons why Rovio can't find its home base properly including:

- You did not properly set Rovio's home base to begin with. Verify that you have saved Rovio's home base first.
- There are obstacles in the way.
- The charging dock is not properly placed.
- The navigation signal of the charging dock is too weak or there is no signal.
- Too many infrared signals or direct sunlight on the sensors causing interference.

Q: *Rovio's interface is loaded but I do not see the video stream ... what's wrong?*

A: Possible causes and solutions:

- Make sure that Rovio is turned on. It might have been turned off while you were logging into Rovio's interface.
- The port forwarding settings are incorrect. Verify your port forwarding settings in your router's firmware interface.
- The required ActiveX is not installed for Internet Explorer. To install the required ActiveX component, click on the link that appears in the Rovio display panel or in the bar that appears at the top of the Internet Explorer window when you are prompted. Follow the onscreen instructions for installing the ActiveX component. If the link does not appear, verify that your pop-up blocker is turned off, and your security settings are NOT set to High.

Q: *Why is there no audio stream from Rovio?*

A: Possible causes and solutions:

- Two-way audio streaming is only supported on PC platforms running Internet Explorer 6.0 and up. Refer to *Appendix A* for a list of browser compatibility features.
- If you are using Internet Explorer on a PC, your volume levels might be low.

Q: I am trying to play back a path that I previously saved but Rovio doesn't seem to play it back properly... What's wrong??

A: There might be a few reasons why Rovio won't play back a path, including:

- Rovio's batteries are weak or depleted and need recharging.
- Rovio cannot detect the Room Beacons, for instance, they might have been moved from their original location or are not powered.
- There are obstacles in the way.
- The navigation signal is too weak or there is no signal.
- Too many infrared signals or direct sunlight on the sensors causing interference.

For more answers to questions, refer to www.myrovio.com or the WowWee Support site at www.wowweesupport.com.

Appendix A

Rovio browser and platform compatibility

Appendix A

Rovio browser and platform compatibility

This table outlines Rovio browser and platform compatibility.

Internet browser	Platform				
	PC computer	Mac computer	iPhone/ Pod Touch	Nintendo Wii	Mobile devices with embedded browser
Internet Explorer	x	*			√ o
Mozilla Firefox	o	o			
Safari	o	o	o		o
Opera	o	o		o	

x = Two-way mono audio streaming* and MPEG4 video streaming.

o = Supports M-JPEG (motion JPEG) streaming. No audio.

√ = For Internet Explorer Mobile, image must be requested manually (i.e. not automatic streaming video). No audio.

* Note on Mac platforms,Internet Explorer is no longer supported as of version 5.2.3.

Appendix B

Terminology

Some of the terms used in this manual are specific to Rovio.

- **ActiveX:** Used to create software components for a specific function or set of functions for Windows platforms. Rovio uses ActiveX in Internet Explorer to allow streaming video and audio.
- **Ad hoc:** In networking, a type of protocol in which the network is created “on-the-fly” or decentralized. When you connect directly to Rovio using your computer, you are connecting to it using an Ad hoc connection (vs. connecting to it through a router).
- **DHCP:** *Dynamic host Configuration Protocol*. A type of networking protocol for computer which determines the IP address when using dynamic IP addressing.
- **IP address:** Internet Protocol address. A unique address for electronic devices such as computers or routers to identify the device over a computer network.
- **MAC address:** *Media Access Control address*. An identifier for most network adapters that distinguishes hardware devices from each other on a network. Sometimes referred to as an Ethernet address.
- **Ports:** A virtual data connection to exchange data, especially between computers and the Internet.
- **SSID:** *Service set identifier*. Used to identify a router.
- **Subnet mask:** A range of logical addresses for which all devices in the network are members.
- **Way points:** In navigation, a reference point or location reference. For Rovio, a way point can be a location in your home which it can save to memory and to which it will drive when playing back paths..
- **Wi-Fi:** Wireless technology.

Index

A

- accounts
 - managing 32
- ActiveX 46, 49
- Ad hoc 49
- Ad hoc setup
 - Mac users 17
 - PC users 16
- administrative privileges 17
- aspect ratio 28
- audio levels
 - output 28
- audio stream
 - troubleshooting 46

B

- batteries
 - charging 14
 - installing 13
- battery
 - indicator 29
 - requirements 10
- brightness 28, 30
- browser compatibility 48
- browsers
 - Internet Explorer 48
 - Mozilla Firefox 48
 - Opera 48
 - Safari 48

C

- channel
 - Wi-Fi 33
- charging dock 14, 21
 - assembling 10–11
 - disassembling 12
 - location 10
 - overview 9
 - powering 11, 12
 - setup 12
- connection
 - Ad hoc 17, 19

D

- DHCP 49
- DHCP settings 34
- DNS server 34, 35
- domain name 40
- domain name system. *See* DNS sever

E

- encryption 33
 - router 33

F

- frame rate 30

H

- Home button 14, 27, 46
- home position. *See* Home button; *See also* Save
 - Home button
- setting 21

I

- infrared beams 10
- interface 19
- Internet Explorer 46, 48
- IP address
 - Rovio 34
- IP address 49
 - pinging 18
 - Rovio default 19
- IR Radar 31

M

- MAC address 33, 49
- Mac user 15
- modes
 - Ad hoc 33
 - infrastructure 20, 33
- movements
 - turning 31
- movement settings 30
- Mozilla Firefox 48

N

- navigation
 - signal strength 29
- network settings 33

O

- obstacle detection 31
- Opera 48

P

- package contents 7
- paths 27
 - deleting 27
 - deleting all saved 27
 - interrupting driving 27
 - recording 27
 - saving 27
- platform compatibility 48
- port 80 38

- port 554 38
- port forwarding 38
- Ports
 - definition 49
- power
 - requirements 10
- power switch 22

R

- Room Beacon. *See* True Track Room Beacon
- room ID number 29
- Rovio
 - configuring the first time 15
 - default IP address 19
 - overview 8
 - reconfiguring 44
- Rovio Setup CD 15, 16
- Rovio Setup software 15
 - installing on PC 15
 - uninstalling 21

S

- Safari 48
- Save Home button 21, 27
- screen captures
 - emailing 31
- security settings 32
- self-docking function 10, 12
- settings
 - DHCP 34
 - email 32
 - movement 30
 - network 33
 - security 32
 - video 30
 - wireless connection 33
- SMTP server 31
- software
 - setup 15
- speaker level 28
- SSID 33, 49
- status
 - indicator
 - driving 29
- subnet mask 34
- Subnet mask 49

T

- TCP/IP port
 - external 38
 - internal 38
- True Track Beacon 11–12
- TrueTrack Beacon 22
- TrueTrack Room Beacon 29

U

- USB 15, 16

V

- video
 - quality 27
 - speed 27
- video quality 30

W

- way points 27
 - definition 49
- web port 33
- WEP 64 33
- WEP 128 33
- WEP key 33
- WEP password 15. *See* WEP key
- wireless
 - signal strength 29
- wireless connection settings 33
- WPA password 15

WOWWEE 180-DAY LIMITED WARRANTY

WowWee's warranty obligations for this Rovio (this "Product") are limited to the terms set forth below.

WowWee Group Limited ("WowWee") warrants to the original end-user purchaser that this Product will be free from defects in materials and workmanship under normal use for a period of 180 days from the date of retail purchase (the "Warranty Period"). This warranty is extended only to the original end-user purchaser of a new product that was not sold "as is".

If a defect arises:

(1) you may within 30 days from the date of retail purchase (or such other period specified by the return policies of the place of purchase) return this Product to the place of purchase, together with the original proof of purchase and either the original box or the UPC code label from the box, and this Product will be replaced or, in the event that a replacement for this Product is not available at the place of purchase, either a refund of the purchase price for this Product or an store credit of equivalent retail value will be provided; or

(2) you may after the day that is 30 days from the date of retail purchase (or such other period specified by the return policies of the place of purchase) and within the Warranty Period contact WowWee Customer Support to arrange for the replacement of this Product. In the event that a replacement for this Product is not available this Product will be replaced by WowWee with a product of equivalent or greater retail value.

A purchase receipt or other proof of the date of retail purchase is required in order to claim the benefit of this warranty.

If this Product is replaced, the replacement product becomes your property and the replaced Product becomes WowWee's property. If the place of purchase refunds the purchase price of this Product or issues a store credit of equivalent retail value, this Product must be returned to the place of purchase and becomes WowWee's property.

EXCLUSIONS AND LIMITATIONS

This warranty covers the normal and intended use of this Product. This warranty does not apply: (a) to damage caused by accident, abuse, unreasonable use, improper handling and care or other external causes not arising out of defects in materials or workmanship; (b) to damage caused by power line surge, lightning or acts of God; (c) to damage caused by service performed by anyone who is not an authorized representative of WowWee; (d) to any hardware, software or other add-on components installed by the end-user; (e) if this Product has been disassembled or modified in any way; (f) to faulty installation or set-up adjustments; (g) to consumable parts, such as batteries, unless damage has occurred due to a defect in materials or workmanship; (h) to cosmetic damage, including but not limited to scratches, dents or broken plastic, or normal wear and tear. Regardless of whether the camera is in use or not, exposure to extremely bright lights or objects can damage the CMOS camera sensor. This warranty specifically excludes any damage to the CMOS sensor resulting from exposure to extremely bright lights or objects, whether accidental or deliberate.

THIS WARRANTY GIVES YOU SPECIFIC LEGAL RIGHTS AND YOU MIGHT ALSO HAVE OTHER RIGHTS THAT VARY FROM STATE TO STATE. WOWWEE'S RESPONSIBILITY FOR PRODUCT DEFECTS IS LIMITED TO THE REPLACEMENT OF THIS PRODUCT OR THE REFUND OF THE PURCHASE PRICE FOR THIS PRODUCT. ALL EXPRESS AND IMPLIED WARRANTIES, INCLUDING BUT NOT LIMITED TO ANY IMPLIED WARRANTIES AND CONDITIONS OF MERCHANTABILITY AND FITNESS FOR A PARTICULAR PURPOSE, ARE LIMITED IN TIME TO THE TERM OF THIS LIMITED WARRANTY. NO WARRANTIES, WHETHER EXPRESS OR IMPLIED, WILL APPLY AFTER THE EXPIRATION OF THE LIMITED WARRANTY PERIOD. If any term of this warranty is held to be illegal or unenforceable, the legality or enforceability of the remaining terms shall not be affected or impaired.

EXCEPT AS PROVIDED IN THIS WARRANTY AND TO THE EXTENT PERMITTED BY LAW, WOWWEE IS NOT RESPONSIBLE FOR DIRECT, SPECIAL, INCIDENTAL OR CONSEQUENTIAL DAMAGES HOWSOEVER CAUSED RESULTING FROM BREACH OF WARRANTY OR CONDITION OR UNDER ANY OTHER LEGAL THEORY, INCLUDING BUT NOT LIMITED TO LOSS OF USE. THE FOREGOING LIMITATION SHALL NOT APPLY TO DEATH OR PERSONAL INJURY CLAIMS, OR ANY STATUTORY LIABILITY FOR INTENTIONAL AND GROSS NEGLIGENT ACTS AND/OR OMISSIONS.

SOME STATES DO NOT ALLOW THE EXCLUSION OR LIMITATION OF INCIDENTAL OR CONSEQUENTIAL DAMAGES, OR LIMITATIONS ON HOW LONG AN IMPLIED WARRANTY LASTS, SO THESE LIMITATIONS MIGHT NOT APPLY TO YOU.

Valid only in U.S.A.

For more information on Rovio, go to

www.myrovio.com

If you have any questions that are not answered in this manual, refer to

www.wowweesupport.com

To see the full range of WowWee products, go to

www.wowwee.com

Register your Rovio at

www.wowwee.com



This device complies with Part 15 of the FCC Rules. Operation is subject to the following two conditions: (1) This device may not cause harmful interference, and (2) This device must accept any interference received, including interference that may cause undesired operation.

For these purposes, the party responsible is:

WowWee USA Inc.
875 Prospect Suite #202
La Jolla, CA 92037

NOTE

This equipment has been tested and found to comply with the limits for a class B digital device, pursuant to part 15 of the FCC rules. These limits are designed to provide reasonable protection against harmful interference in a residential installation. This equipment generates, uses and can radiate radio frequency energy and, if not installed and used in accordance with the instructions, may cause harmful interference to radio communications.

However, there is no guarantee that interference will not occur in a particular installation. If this equipment does cause harmful interference to radio or television reception, which can be determined by turning the equipment off and on, the user is encouraged to try and correct the interference by one or more of the following measures:

- Reorient or relocate the receiving antenna
- Increase the separation between the equipment and receiver
- Connect the equipment into an outlet on a circuit different from that to which the receiver is connected
- Consult the dealer or experienced radio/TV technician for help

CAUTION

Changes or modifications not expressly approved by the party responsible for compliance could void the user's authority to operate the equipment.

Manufactured and distributed by © 2007 WowWee Group Limited.
Product names, designations, and logos are trademarks or registered trademarks of WowWee Group Limited. All rights reserved.

Energy Plaza, 3/F
92 Granville Road
T.S.T. East, Hong Kong

3500 de Maisonneuve West
Suite 800
Montreal, QC H3Z 3C1 Canada

Consumer Hotline: 1-800-310-3033
Customer Service: www.wowweesupport.com
www.wowwee.com

We recommend that you retain our address for future reference.

Product and colors may vary.

Packaging printed in China.

This product is not suitable for children under 3 years because of small parts - choking hazard.