



INSIGNIA GUIDE

BOY SCOUTS OF AMERICA

Contents

Official Policy	Inside front cover	Varsity Scout Insignia	28
Excerpts from the Rules and Regulations.	1-2	Explorer Insignia	29-35
Special Regulations	3-7	Sea Explorer Insignia.	31-33, 35
Tiger Cub Insignia.	8	Universal and Nonunit Insignia	36-46
Cub Scout and Webelos Scout Insignia	9-15	Flags	47-48
Boy Scout Insignia.	16-27	Index.	49-50

Official Policy

The Boy Scouts of America has always been a uniformed body. Its uniforms help to create a sense of belonging. They symbolize character development, citizenship training, and personal fitness. Wearing a uniform gives youth and adult members a sense of identification and commitment.

Personal equality. The uniform represents a democratic idea of equality; bringing people of different racial, economic, religious, national, ethnic, political, and geographical backgrounds together in the Scouting tradition.

Identification. It identifies youth and adults as members of the Boy Scouts of America, visible as a force for good in the community. When properly and smartly worn, the uniform can build good unit spirit. When worn on the correct occasions, it can attract new members.

Achievement. The uniform shows the wearer's activity, responsibility, and achievement. What each youth or adult member has accomplished with program opportunities can be recognized by the insignia worn on the uniform.

Personal commitment. The uniform is a constant reminder to every Cub Scout, Boy Scout, Varsity Scout, Explorer, and adult of their commitment to the ideals and purpose of the Boy Scouts of America. It encourages them to take Scouting seriously because of the investment in uniforms by parents of youth and by adults. It is a way of making visible members' commitment to a belief in God, loyalty to country, and to helping others at all times.

The leaders of Scouting—both volunteer and professional—promote the wearing of the correct complete uniform on all suitable occasions.

The Rules and Regulations and policy. The succeeding pages contain our uniform policy as taken from the *Rules and Regulations of the Boy Scouts of America*. The following chapters contain applications of the regulations to each program area. Neither the Rules and Regulations of the Boy Scouts of America, the policy, nor the program applications may be added to or changed in any way unless approved by the national Executive Board of the Boy Scouts of America through its Program Group Committee.

Excerpts from the Rules and Regulations

NOTE: The name of the Corporation is Boy Scouts of America. For convenience, in the Rules and Regulations, the word "Corporation" is sometimes used instead of the official name.

INSIGNIA, UNIFORMS, AND BADGES

ARTICLE X, SECTION 4.

GENERAL

Clause 1. The badges and other official insignia and the uniforms of the Boy Scouts of America shall be made available to, and used only by, registered youth members or officials

and other members who have satisfactorily complied with the requirements prescribed by the Corporation.

OFFICIAL UNIFORMS

Clause 2. The official uniforms authorized as evidence of official relationship to the Boy Scouts of America shall be those approved by action of the Executive Board of the Boy Scouts of America from time to time, as illustrated and correctly described in the handbooks, catalogs, and other official publications of the Boy Scouts of America.

Clause 4. Prohibition of Alteration or Imitation.

(a) No alteration of, or additions to, the official uniforms, as described in the official publications, or the rules and regulations covering the wearing of the uniform and the proper combinations thereof on official occasions, may be authorized by any Scouting official or local council or any local executive board or committee, except the Executive Board of the Boy Scouts of America after consideration by the Program Group Committee.

PROTECTION OF UNIFORMS

Clause 3. Restricted Sale and Use. The sale and use of the appropriate uniform as specified shall be restricted to members of the Boy Scouts of America who are registered and in good standing, according to the records of the organization. It shall be the responsibility of all members of the Boy Scouts of America and especially of all commissioned officers and chartered councils to cooperate with the Corporation in preventing the use of the official uniforms by those who are not members of the organization in good standing.

(b) Imitation of United States Army, Navy, or Marine Corps uniforms is prohibited, in accordance with the provisions of the organization's Congressional Charter.

DISTRIBUTION OF UNIFORMS

Clause 5. The official uniforms and parts thereof shall be issued only as authorized by the Executive Board of the Boy Scouts of America and sold either directly by the national office—

through responsible local merchants designated as local Scouting distributors—or through designated local councils. Local Scouting distributors may be appointed and licensed and the licenses revoked only by the national office, but chartered local councils may make recommendations for such actions.

USE OF UNIFORM

Clause 6. The official uniforms are intended primarily for use in connection with Scouting activities as defined by the national Executive Board, and their use may be approved by the

local council executive board for council events or activities under conditions consistent with the *Rules and Regulations of the Boy Scouts of America*.

Clause 7. Use Abroad. Members of the Boy Scouts of America, whose address of registration is within the United States, shall not wear the official uniforms nor any official Scouting badges and insignia outside the limits of the United States except when carrying international letters of introduction issued by the Corporation or as members of groups traveling with tour permits issued by the Corporation.

PROTECTION AND USE OF BADGES AND INSIGNIA

Clause 8. All badges and insignia of the Boy Scouts of America shall be used exclusively by members of the Boy Scouts of America, registered and in good standing according to the records at the national office, who qualify in accordance with the provisions herein set forth or as may be authorized by the Executive Board

from time to time and published in the official handbooks by the Corporation.

Clause 9. All badges and insignia shall remain the property of the Boy Scouts of America subject to recall for cause by the Corporation or its duly authorized representative.

ALTERATION OF BADGES AND INSIGNIA

Clause 10. No alteration of, or additions to, the official badges and insignia or in the rules and regulations governing their use or their location upon the uniform may be authorized by

any Scouting official, local council, local executive board, or committee except the national Executive Board of the Boy Scouts of America and committees specifically authorized thereof.

SPECIAL LOCAL BADGES AND INSIGNIA

Clause 11. Local councils are authorized to adopt special badges and insignia as awards for particular purposes in harmony with national policies and to permit their use upon the official

uniform in accordance with the Rules and Regulations of the Corporation, but such awards must be approved as to purpose and design by the Corporation in advance.

AUTHORIZATION

Clause 12. The national office shall have the sole right to authorize the use of insignia, words, phrases, designation marks, pictorial representation, and descriptive remarks relating to the program of the Corporation on commercial prod-

ucts, promotional efforts, and/or sale and distribution to members of the Boy Scouts of America and/or the general public.

The use of same by local councils shall be only as authorized and approved by the national office.

Special Regulations

AWARDS FROM OTHER SCOUT ASSOCIATIONS

Scouters occasionally receive awards from Scouting associations of other nations, and it is important that they know how these awards should be worn. This does not include jamboree patches. Following are the regulations for wearing such awards:

1. They are always worn when visiting the country whose Scouting association

presented the award or when attending a meeting or function attended by Scouters from that country.

2. Medals awarded by other associations are worn above the left breast pocket.

BADGES OF OTHER ORGANIZATIONS

The general rule is that badges awarded by organizations other than the Boy Scouts of America may not be worn on an official uniform. This includes military medals and service ribbons. There are, however, notable exceptions. Among

them are religious emblems and those special badges approved by local councils in conjunction with the national Program Group Committee such as Historic Trails medals.

BADGE SWAPPING

Boy Scouts and Explorers attending jamborees may swap among themselves articles and novelties of a local or regional nature. The swapping of such items as badges of office, rank, distinguished service, training, performance, achievement, and distinction, however, is a vio-

lation of article X of the Rules and Regulations of the Boy Scouts of America, forbidding the holding of these badges by any but the members who have complied with the requirements for them.

HEADGEAR REGULATIONS

Official headgear may be worn while the unit or individual is participating in an indoor formal ceremony or service duty, except in religious institutions where custom forbids. Typical indoor activities of this type are flag ceremonies, inspections, orderly duty, or ushering service. In any informal indoor activity where no official ceremony is involved, the headgear is removed as when in street clothes. The Scouter dress uniform is always worn without headgear. Pins may

be worn on the jamboree hat but only while at the jamboree and Webelos activity badges may be worn on the Webelos cap (see page 10). As part of the First Class Emphasis, the large standard metal pin, No. 00017, has been reinstated as an option to the cloth First Class rank badge. The large pin also may be worn only by boys on the front of the campaign hat, No. R501. No other pins may be worn on official headgear of the BSA.

COUNCIL SHOULDER PATCHES

A custom-designed multicolor council shoulder emblem is designed for each council and dramatizes local tradition for all members of the

council. In this No. 16000 series, the last three digits of the catalog number represent the council number.

DISTRICT INSIGNIA

Districts are operational arms of the local council. Individuals are not identified as residents of a district, but of the local council and the Boy Scouts of America. For this reason district insignia is not authorized for wear on the

uniform. Where it seems desirable to identify district participation in council activities, district flags or banners may be authorized. They are described in the flag portion of this book.

DRUM AND BUGLE CORPS UNIFORMS

Boy Scouts or Explorers who are members of bands, drill teams, or drum and bugle corps affiliated with a unit or a local council must wear the official uniform for their registration status. For example, they may not wear the Explorer uniform unless they are registered Explorers. The dark green shirt may be worn by older Scouts.

The wearing of special helmets, scarves, gloves, unofficial leggings, and the carrying of

ceremonial guns or swords by members of such organizations using the uniforms of the Boy Scouts of America is in violation of the Rules and Regulations of the Boy Scouts of America.

The musician badge is the only special insignia that may be worn by the members of these organizations. It is worn on the right sleeve centered just below (1/2 inch) the patrol medallion.

EXCESS INSIGNIA

With the exception of the Cub Scout badges of rank and Arrow Points, members wear only the insignia that show their present status in the movement. **Every effort should be made to keep the uniform neat and uncluttered.** Previously earned badges and insignia—not representing present status—make a fine display on a

BSA red patch vest, a trophy hide or blanket, exhibited in the home of the recipient, or at functions where such a display is invited. Only temporary patches (no badges of rank) may be worn on the back of the merit badge sash. Only one merit badge sash may be worn.

JAMBOREE INSIGNIA

Jamboree emblems for Boy Scouts are worn only by registered jamboree participants and staff and are centered immediately above the Boy Scouts of America strip or, for Explorers, above the right shirt pocket above the Explorer

strip. No more than one jamboree patch may be worn on the shirt.

If the wearer has an interpreter strip above the pocket, merely move the jamboree emblem upward sufficiently to accommodate it.

JACKETS AND THEIR INSIGNIA

Multicolored jackets in nylon, wool, and poplin are available for optional wear by youth members and adult leaders. The proper universal emblem for the branch of Scouting the wearer is engaged in should be worn on the left pocket or, in case of a zippered jacket or the action jacket for Explorers, above the pocket. The Philmont bull emblem is especially designed for the red wool jac-shirt to be sewn on the left shoulder above the pocket. On all jackets the Philmont Scout Ranch, Philmont Training Center, or high-adventure base emblems may be worn centered on the right pocket or in the same relative position if there is no pocket. Explorer posts may wear their post or special-interest emblem on the right sleeve 2 inches below the

shoulder seam or they may elect to wear a 6-inch emblem on the back of the jac-shirt or the action jacket—not both. The Order of the Arrow has adopted the jac-shirt as its official jacket, and members may wear the 6-inch national Order of the Arrow patch centered on the back. The large Philmont, NESAs, jamboree, National Camping School, Scoutmaster Award of Merit, and international participant emblems are approved to be worn on the back of the jacket. Only one such emblem may be worn at a time. The Venture/Varsity letter may be worn on the center of the right side of the red or blaze nylon or poplin jacket. In all cases, the lightweight jacket is an alternate for the jac-shirt, and this insignia may be worn on it in the same way.

BADGES OF RANK ARE FOR BOYS

In Scouting, **the advancement program is intended for boys only.** Scouters should neither seek awards designed for boys nor wear them on the Scouter uniform except for square

knots representing the Arrow of Light Award, Eagle Scout Award, Explorer Achievement Award, Quartermaster, or religious emblems earned as a youth member.

TWO BADGES WITH THE SAME MEANING

Cloth badges and embroidered square knots are representative of metal pin-on awards and are designed for greater convenience of the

wearer. Generally, when a cloth badge is worn, the metal one is not worn.

TEMPORARY INSIGNIA

Temporary insignia are issued for such events as summer camp, camporees, and Scouting shows. Order of the Arrow regional and national meetings and training activities may also provide them. **Only one such patch may be worn at a time.** The patch is worn centered on the right pocket and must not exceed the dimension of the seams of the pocket, nor extend higher than the lowest tip of the pocket flap. It may be either sewn or suspended from under the flap attached to the button. The Progress Toward Ranks or Webelos compass points emblem may be worn by a Cub Scout or

Webelos Scout suspended from the right pocket button in addition to sewn-on temporary insignia.

Female leaders wearing the yellow Cub Scout leader blouse or the tan Webelos den leader blouse may wear one temporary insignia centered above the Boy Scouts of America strip. Women in Boy Scouting place temporary insignia the same as on the men's shirt.

Commissioners and other conducting inspectors should know that temporary insignia are

not required for correct uniforming. They should not deduct points for failure to wear such insignia, but, if worn, they must be worn correctly.

Consider displaying temporary insignia in ways other than on the official uniform. Here are some suggestions:

- Wear it on a BSA red patch vest, campfire robe or blanket, or special neckerchief.
- Display it on a wall plaque, trophy hide, or mounted in a frame.
- Or, make a special neckerchief slide, sectional totem pole, or flagpole insignia for display.

SCOUTING IDENTIFICATION

It is mandatory that all badges worn on BSA uniforms contain identification including **one** of the following:

- Corporate name (Boy Scouts of America)
- Corporate initials (BSA)

- BSA fleur-de-lis (universal with Eagle or plain one-color)
- Big E, Explorer, Exploring

This means that all council-approved Cub Scout, Boy Scout, Varsity Scout, and Explorer badges also must bear a BSA identification to protect them, and that these BSA cloth badges must be approved by the national office.

THE NECKERCHIEF

Official neckerchiefs. Official neckerchiefs are triangular in shape. Cub Scout neckerchiefs are gold with blue border for boys working in the *Wolf Cub Scout Book*, light blue with dark blue border for boys working in *The Big Bear Cub Scout Book*. The gold universal Cub Scout emblem is displayed in a central position on the downward corner. Cub Scout leaders may wear the blue and gold Cub Scout leader's neckerchief. Webelos Scouts wear the gold, green, and red plaid neckerchief with the Webelos emblem on the downward corner. A Webelos leader wears a neckerchief similar to the Webelos Scout neckerchief, except that it has gold embroidered edging and is larger.

A special Lone Scout neckerchief, No. 00703, is gold with the black and red printed insignia of the lone Indian. It is worn by both Lone Cub Scout and Lone Boy Scout.

Boy Scout neckerchiefs are optional. The troop decides by vote, and all members abide by the decision. If not worn, then shirt is worn with open collar. Boy Scout and Boy Scout leader neckerchiefs may be worn in a variety of plain colors and contrasting borders. Those available through Supply Division include the embroi-

dered universal Scouting emblem if permanent, or printed if not. Troops choose their own official neckerchief.

Local councils may prescribe the specific official neckerchief to be worn by Boy Scouts and Scouters on a council or district basis.

The neckerchief is worn only with the official uniform and never with T-shirts or civilian clothing. All members of a troop wear the same color.

Special neckerchiefs, the same size as the official ones, may be authorized by local councils. Such neckerchiefs may include identification of the chartered organization. The standard designed neckerchief may be personalized with troop number, city, and state.



Cub Scout
slide



Webelos
slide



Boy Scout
slide

Neckerchief slides. A number of official slides are available from the Supply Division. Boy-made handicraft slides also may be worn.

HOW TO WEAR THE NECKERCHIEF

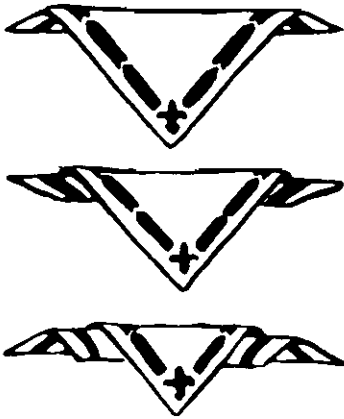

- a. Fold long edge over several flat folds to about 6 inches from tip of neckerchief. A tight fold prevents gathering around the neck and is more efficient than rolling or twirling.

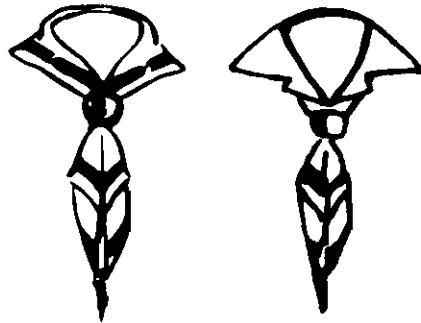

- b. Place around neck of V-neck shirt. On shirts with collars, the unit has a choice of wearing the neckerchief over the turned under collar or under the open collar. It is not worn over the open collar. The collar should not be buttoned.



- c. Draw neckerchief slide over ends and adjust to fit snugly.



- d. By vote of troop, ends may be left hanging loose or may be tied in a slipknot.

BELTS

Cub Scouts wear the official Cub Scout navy blue web belt with metal buckle and Cub Scout emblem. For Webelos Scouts, the official Cub Scout navy blue web belt with metal buckle and Webelos Scout emblem is preferred for wear with either the blue or the tan Webelos uniform. However, Webelos Scouts also have the option of wearing the olive web belt with the metal Boy Scout buckle.

Boy Scouts wear the official olive web belt with the metal Boy Scout buckle.

Female adult Cub Scout leaders wearing the blue and gold uniform also wear the official Cub Scout navy blue web belt with metal buckle and Cub Scout or Webelos Scout emblem. Adult leaders wearing the tan uniform wear the official olive web belt with the metal Boy Scout buckle.

Leather camp, high adventure base, or Wood Badge belts with official BSA buckles also may be worn with the youth or adult uniform.

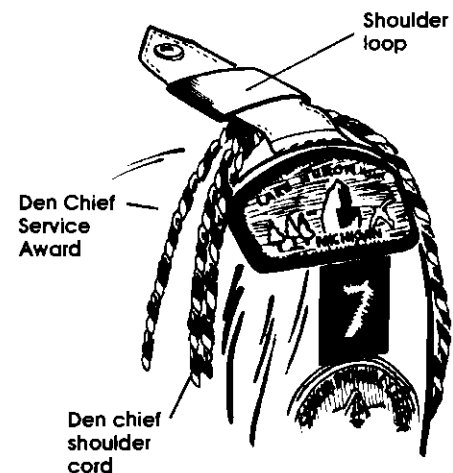

Colored shoulder loops identify the area of Scouting: blue, Cub Scouting; red, Boy Scouting; blaze, Varsity Scouting; green, Exploring; silver, council and district; gold, national and regional. Wear the color for the position in which you are functioning.

Tiger Cub Insignia



Tiger Cubs, BSA, emblem, cloth, No. 00399, Tiger Cub or Tiger Cub partner, civilian wear.



Tiger Cub graduate emblem, cloth, No. 00398, Cub Scout, right pocket.



Tiger Cub group coach, cloth, No. 00327, Cub Scout leader, left sleeve, position 3.

TIGER CUB UNIFORMS

Tiger Cub T-shirt, polo shirt, etc., with Tiger Cub iron-on emblem,* No. 33928, front of shirt. Shirt color is group option.

Adult partner T-shirt, polo shirt, blouse, pullover, etc., with Tiger Cub iron-on emblem.* No. 33928, upper-left front of garment. Shirt color is group option.

Optional crew-neck orange T-shirt; youth, No. 81591 (small), No. 81592 (medium), No. 81593 (large); adult, No. 81691 (small), No. 81692 (medium), No. 81693 (large), No. 81694 (extra large). May be worn in place of the T-shirt and iron-on. Tiger Cub cap, No. 81792 (youth) and No. 81793 (adult), may be worn with either uniform but is not required.



Tiger tracks, No. 33926 (sheet of 12*), Tiger Cubs, BSA, for participation in group activity, front of shirt in any area not covered by another emblem.

**Included in Tiger Cub Family Activity Packet.*

RELIGIOUS EMBLEMS FOR TIGER CUBS



Light of Christ



Maccabee
Jewish

Light of Christ, Roman Catholic, bar pin and medal, Tiger Cub, Tiger Cub T-shirt, or may be worn on Cub Scout uniform, above left pocket.

Maccabee, Jewish, bar pin and medal, Tiger Cub, Tiger Cub T-shirt or may be worn on Cub Scout uniform, above left pocket.

Note: For additional information on religious emblems, write for Religious Emblems Programs flier, No. 5-206A, from the Relationships Division, S226, Boy Scouts of America, 1325 West Walnut Hill Lane, P.O. Box 152079, Irving, TX 75015-2079.

Cub Scout and Webelos Scout Insignia

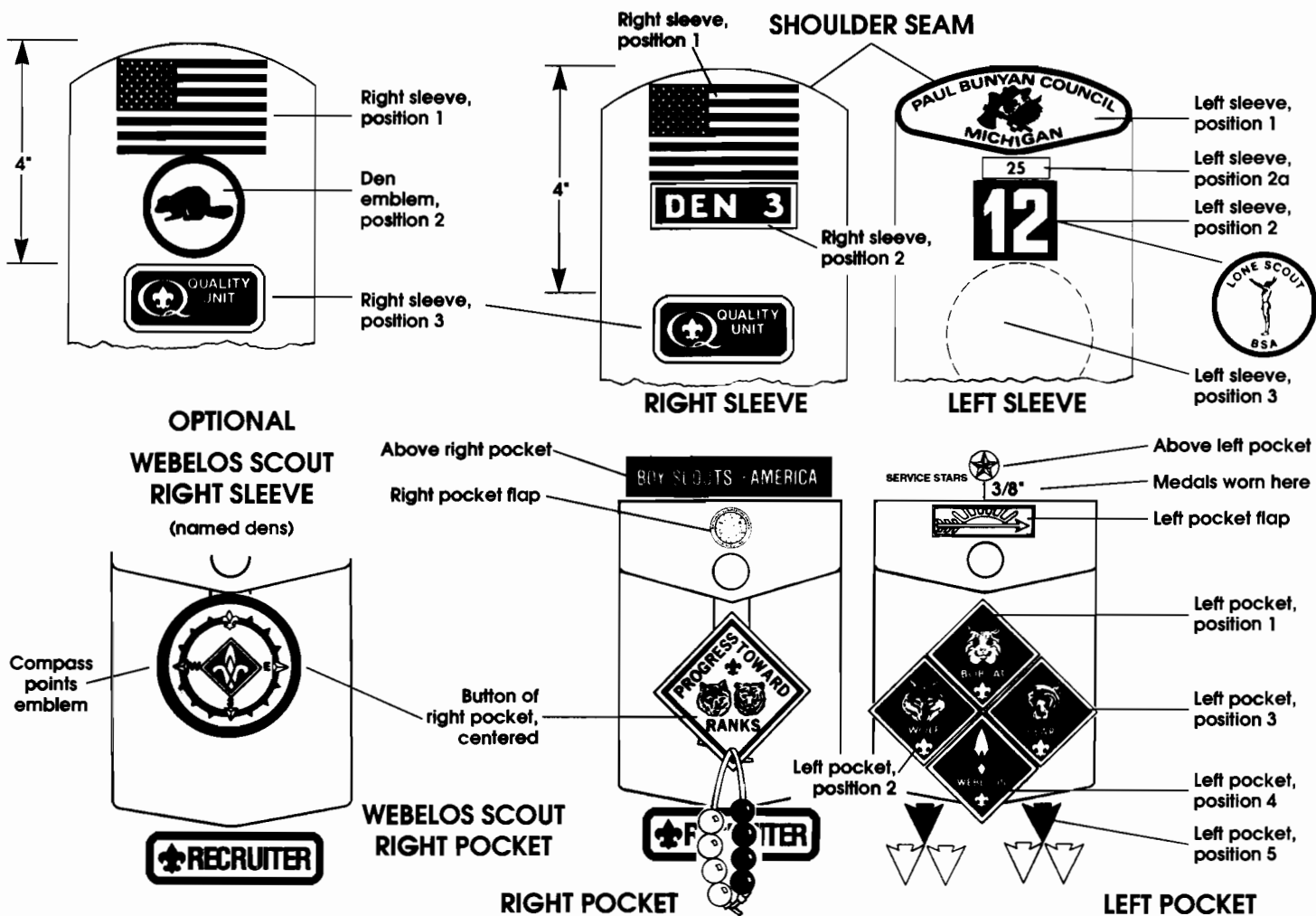

CUB SCOUT PROGRAM IDENTIFICATION

U.S. flag emblem, cloth, red, white, and blue, No. 00103; Cub Scout, Cub Scout leader, right sleeve, position 1. New uniforms have this emblem already sewn in the correct position.

Council shoulder emblem, cloth, No. 16xxx (last three digits, council number), Cub Scout and Cub Scout leader, left sleeve, position 1.

Unit number, cloth, white on red, Nos. 10400 through 10408 (last digit indicates the unit number for 0 through 8); for unit number 9, order No. 10406. Cub Scout and Cub Scout leader, left sleeve, position 2, touching council shoulder emblem if veteran unit bar is not worn. Multiple-digit numbers may be special-ordered—2-digit, No.

10409; 3-digit, No. 10410; 4-digit, No. 10411.

Lone Scout emblem, cloth, red and black on khaki, No. 00352, Cub Scout, left sleeve, position 2.

Veteran unit bars, cloth, Cub Scout and Cub Scout leader, left sleeve, position 2a; 25 years, No. 00133; 50 years, No. 00105; 55 years, No. 00194; 60 years, No. 00195; 65 years, No. 00196; 70 years, No. 00197; 75 years, No. 00107; 80 years, No. 00198.

Den number, gold on blue, Nos. 10701 through 10724 (last two digits indicate the den number); Cub Scout, Webelos Scout, or den leader, right sleeve, position 2, immediately below and touching the U.S. flag.

Only five medals may be worn at a time, pinned in a single row immediately above the seam of the left pocket.

Webelos den emblem, optional (see page 17).

Neckerchief slide, No. 00800; Cub Scout, worn with Cub Scout neckerchiefs.

Neckerchief slide, No. 00891; Webelos Scout, worn with Webelos Scout neckerchief.

Bolo tie, No. 00830; Cub Scout leader, optional wear with open-collar shirt.

Shoulder loops, blue ribbon, No. 00677, Cub Scout leader or Webelos Scout, on shoulder epaulets.

CUB SCOUT ADVANCEMENT

Bobcat badge, cloth, blue and gold, No. 00370, Cub Scout, left pocket, position 1.

Bobcat pin, No. 00041, Cub Scout, worn on civilian clothes.

Progress Toward Ranks, vinyl with thong, yellow beads for Wolf, red for Bear, No. 01804, Cub Scout, right pocket button.

Wolf badge, cloth, red, gold, and gray, No. 00371, Cub Scout, left pocket, position 2. Wolf pin, No. 00030, Cub Scout, civilian wear.

Gold Arrow Point, cloth, No. 00306, Cub Scout, left pocket, position 5.

Silver Arrow Point, cloth, No. 00307, Cub Scout, left pocket, position 5 worn in double rows beneath gold Arrow Point.

Bear badge, cloth, green, gold, and brown, No. 00374, Cub Scout, left pocket, position 3. Bear pin, No. 00031, Cub Scout, civilian wear.

Webelos badge, cloth, blue and gold, No. 00043, Webelos Scout, left pocket, position 4.

Webelos compass points emblem, cloth, No. 00458; device for each four additional activity badges, No. 00459; Webelos Scout, right pocket.



Bobcat



Wolf



Bear



Webelos



Progress Toward Ranks



Gold Arrow Point

Silver Arrow Points



Webelos compass points emblem with compass point devices



Aquanaut



Artist



Athlete



Citizen



Craftsman



Communicator



Engineer



Family Member



Fitness



Forester



Geologist



Handyman



Naturalist



Outdoorsman

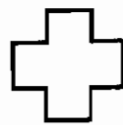

Readyman



Scholar



Scientist



Showman



Sportsman



Traveler

Activity badges, metal pins worn on light blue front panel of Webelos cap by Webelos Scouts. Aquanaut, No. 00465; Artist, No. 00466; Athlete, No. 00467; Citizen, No. 00468; Communicator, No. 00495; Craftsman, No. 00469; Engineer, No. 00470; Family Member, No. 00492; Fitness, No. 00496; Forester, No.

00471; Geologist, No. 00472; Handyman, No. 00493; Naturalist, No. 00473; Outdoorsman, No. 00474; Readyman, No. 00494; Scholar, No. 00475; Scientist, No. 00476; Showman, No. 00477; Sportsman, No. 00478; Traveler, No. 00479.

Arrow of Light Award, cloth, blue on khaki, No. 00044, Webelos Scout, left pocket flap. Arrow of Light Award miniature pin, No. 00115, civilian wear. Arrow of Light Award, metal, No. 00463, Webelos Scout, left pocket flap.



Webelos colors, No. 00452, red, yellow, and green tabs. Pack option for wear by Webelos Scouts, right sleeve, under and touching the U.S. flag, if no den number is worn. (Covers den and Quality Unit insignia.) If den number is worn, under and touching the den number. If colors are worn, activity badges are worn on the tabs.

SPORTS AND ACADEMICS BELT LOOPS AND PINS



CUB SCOUT SPORTS AND ACADEMICS

Cub Scout sports and academics belt loops: Worn on navy blue Cub Scout belt only. Archery, No. 00814; Art, No. 00785; Badminton, No. 00840; Baseball, No. 00817; Basketball, No. 00816; Bicycling, No. 00847; Bowling, No. 00815; Citizenship, No. 00793; Communicating, No. 33033; Fishing, No. 00821; Geography, No. 00792; Golf, No. 00818; Gymnastics, No. 00822; Heritages, No. 00794; Marbles, No. 00819; Mathematics, No. 00791; Music, No. 00787; Physical Fitness, No. 00824;

Science, No. 00788; Skating, No. 00849; Skiing, No. 00820; Soccer, No. 00825; Softball, No. 00823; Swimming, No. 00826; Table Tennis, No. 00827; Tennis, No. 00829; Ultimate, No. 00848; and Volleyball, No. 00828; Cub Scout and Webelos Scout.

Cub Scout sports and academics pins: Cub Scout and Webelos Scout, worn on civilian clothes only. Archery, No. 00832; Art, No. 00781; Badminton, No. 00808; Baseball, No. 00835; Basketball, No. 00834; Bicycling, No. 00800;

Bowling, No. 00833; Citizenship, No. 00797; Communicating, No. 00782; Fishing, No. 00812; Geography, No. 00796; Golf, No. 00836; Gymnastics, No. 00807; Heritages, No. 00798; Marbles, No. 00837; Mathematics, No. 00795; Music, No. 00783; Physical Fitness, No. 00840; Science, No. 00784; Skating, No. 00811; Skiing, No. 00838; Soccer, No. 00841; Softball, No. 00839; Swimming, No. 00842; Table Tennis, No. 00843; Tennis, No. 00845; Ultimate, No. 00810; and Volleyball, No. 00844.

Program letters for sports, No. 00806, and **academics**, No. 00780, Cub Scout, worn on sweater or jacket.



Cub Scout sports emblem, cloth, No. 00805, Cub Scout, Cub Scout leader, worn by participant in program on right pocket.

OUTDOOR PROGRAM



Outdoor program belt buckle, No. 00503, recognition for Cub Scouts, Webelos Scouts, family members, and staff members who actively participate in Cub Scout day camp or resident camp. A Cub

Scout miniature device, No. 00504, may be embedded in the buckle for each year of participation (up to four). The definition of participation is determined by the local council.

CUB SCOUT PACK BADGES OF OFFICE



Chairman, pack committee, cloth, gold on blue, No. 00380, Cub Scout leader, left sleeve, position 3.



Den leader, cloth, gold on blue, No. 00376, Cub Scout leader, left sleeve, position 3.



Assistant Webelos den leader, cloth, gold on blue, No. 00462, Cub Scout leader, left sleeve, position 3.



Pack committee, cloth, gold on blue, No. 00379, Cub Scout leader, left sleeve, position 3.



Assistant den leader, cloth, gold on blue, No. 00375, Cub Scout leader, left sleeve, position 3.



Tiger Cub group coach, cloth, No. 00327, Cub Scout leader, left sleeve, position 3.



Cubmaster, cloth, silver on blue, No. 00383, Cub Scout leader, left sleeve, position 3.



Den leader coach, cloth, gold on blue, No. 00378, Cub Scout leader helping Cub Scout or Webelos Scout dens, left sleeve, position 3.

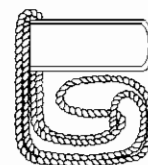

Denner shoulder cord, gold double-strand, No. 00368, Cub Scout, over left shoulder.



Assistant Cubmaster, cloth, gold on blue, No. 00381, Cub Scout leader, left sleeve, position 3.



Webelos den leader, cloth, gold on blue, No. 00460, Cub Scout leader, left sleeve, position 3.

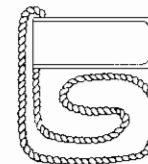

Denner shoulder tab, felt, gold, No. 00369, Cub Scout, on left shoulder, by former denners.

Assistant denner shoulder cord, gold single-strand, No. 00385, Cub Scout, over left shoulder.

CUB SCOUT PARTICIPATION



Attendance pin and 1-year bar. No. 00051, Cub Scout, above left pocket; Nos. 00052 through 00060 (last digit indicates years of attendance, e.g., 4-year bar, No. 00054, 10-year bar, No. 00060, etc.), Cub Scout, attached to attendance pin.



Pinewood derby medals, with red, white, and blue ribbons, Cub Scout, above left pocket: blue background, No. 00974; red background, No. 00975; white background, No. 00976.



National Summertime Pack Award, pin, No. 00464, Cub Scouts and Webelos Scouts, right pocket flap.



Cub Scout World Conservation Award, No. 00139, Cub Scout, right pocket.

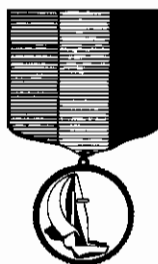

Regatta derby medals, with red, white, and blue ribbons, Cub Scout, above left pocket: blue background, No. 00981; red background, No. 00982; white background, No. 00983.



Recruiter strip, cloth, No. 00219, Cub Scout, below right pocket.



Quality Unit, cloth, youth member and leader, right sleeve, position 3. Only the most recently earned Quality Unit emblem may be worn. See your local council for specific year numbers.



Tiger Cub Graduate emblem, cloth, No. 00398, Cub Scout, right pocket; hat pin, No. 00088.



Cub Scout activity medals, with blue and gold ribbon, Cub Scout above left pocket: Bronze, No. 00934; Silver, No. 00935; Gold, No. 00936.

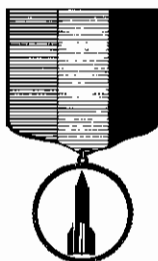

Space derby medals, with red, white, and blue ribbons, Cub Scout, above left pocket: blue background, No. 00986; red background, No. 00987; white background, No. 00988.

CUB SCOUT LEADER RECOGNITION

Trained Leader emblem, No. 00280, is available for all leaders who have completed the basic training program appropriate to their positions. The emblem is worn immediately below and



touching the emblem of office for which it was earned. Den chiefs who have completed the den chief

training conference may wear the Trained Leader emblem beneath their badge of office.

Note: The Trained Leader emblem may be worn *only* in connection with the emblem of office for which basic training has been completed.



Cubmaster Award, gold ribbon with two blue stripes, No. 00910, Cub Scouter, pendant worn suspended from ribbon around neck.



Den Leader Award, blue ribbon with gold stripe, No. 00950, Cub Scouter, pendant worn suspended from ribbon around neck.

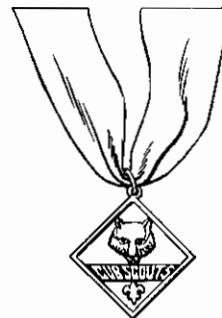

Webelos Den Leader Award, gold ribbon, No. 00952, Cub Scouter, pendant worn suspended from ribbon around neck.

Cub Scout Leader Award embroidered knots, see pages 44–45.



Cub Scouter Award, gold ribbon with blue stripe, No. 00951, Cub Scouter, pendant worn suspended from ribbon around neck.



Den Leader Coach Award, blue ribbon, No. 00953, Cub Scouter, pendant worn suspended from ribbon around neck.



Tiger Cub Group Coach Award, orange ribbon with black stripe, No. 17687, Cub Scouter, pendant worn suspended from ribbon around neck.

RELIGIOUS EMBLEMS FOR CUB SCOUTS

Most Cub Scout religious emblems consist of a bar pin and pendant. All are worn above the left pocket.

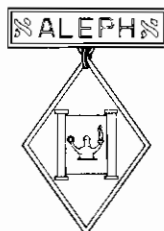

Aleph
Jewish



Bismillah
Islamic

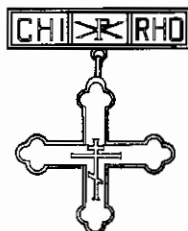

Chi Rho
Eastern Orthodox
(Webelos age)



Dharma
Hindu



Faith in God
Church of Jesus Christ of Latter-day Saints
(Webelos age)



God and Me
Protestant



God and Country
First Church of Christ Scientist



God and Country—God and Family
Episcopal
(Webelos age)



God and Country—God and Family
Protestant
(Webelos age)



God and Family
Lutheran



God and Family
Salvation Army for Non-Salvationists
(Webelos age)



God in Me
Association of Unity Churches



Joyful Servant
Churches of Christ



Love and Help
Unitarian Universalist



Love for God
Meher Baba



Love of God
(Mlasc Boga)
Polish National Catholic



Metta
Buddhist



Parvuli Dei
Roman Catholic and Eastern Rite Catholic



Saint George
Eastern Orthodox



Saint Gregory
Eastern Diocese of the Armenian Church of
America



Silver Crest
Salvation Army for Salvationists
(Webelos age)



That of God
Religious Society of Friends (Quakers)



Unity of Mankind
Baha'i



Religious emblem square knot, cloth, silver knot on purple, No. 05007, youth member or Scouter, above left pocket; cloth, purple knot on silver, No. 05014, Scouter only, above left pocket. See note on page 45.

Note: For additional information on religious emblems, write for Religious Emblems Programs flier, No. 5-206A, from the Relationships Division, S226, Boy Scouts of America, 1325 West Walnut Hill Lane, P.O. Box 152079, Irving, TX 75015-2079.

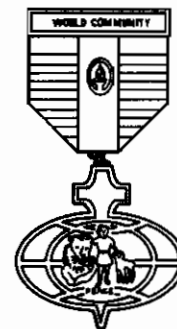

Light of the World, The World Community, Reorganized Church of Jesus Christ of Latter Day Saints, bar pin, ribbon, and medal with device attached to ribbon, Cub Scout, above left pocket.

Boy Scout Insignia

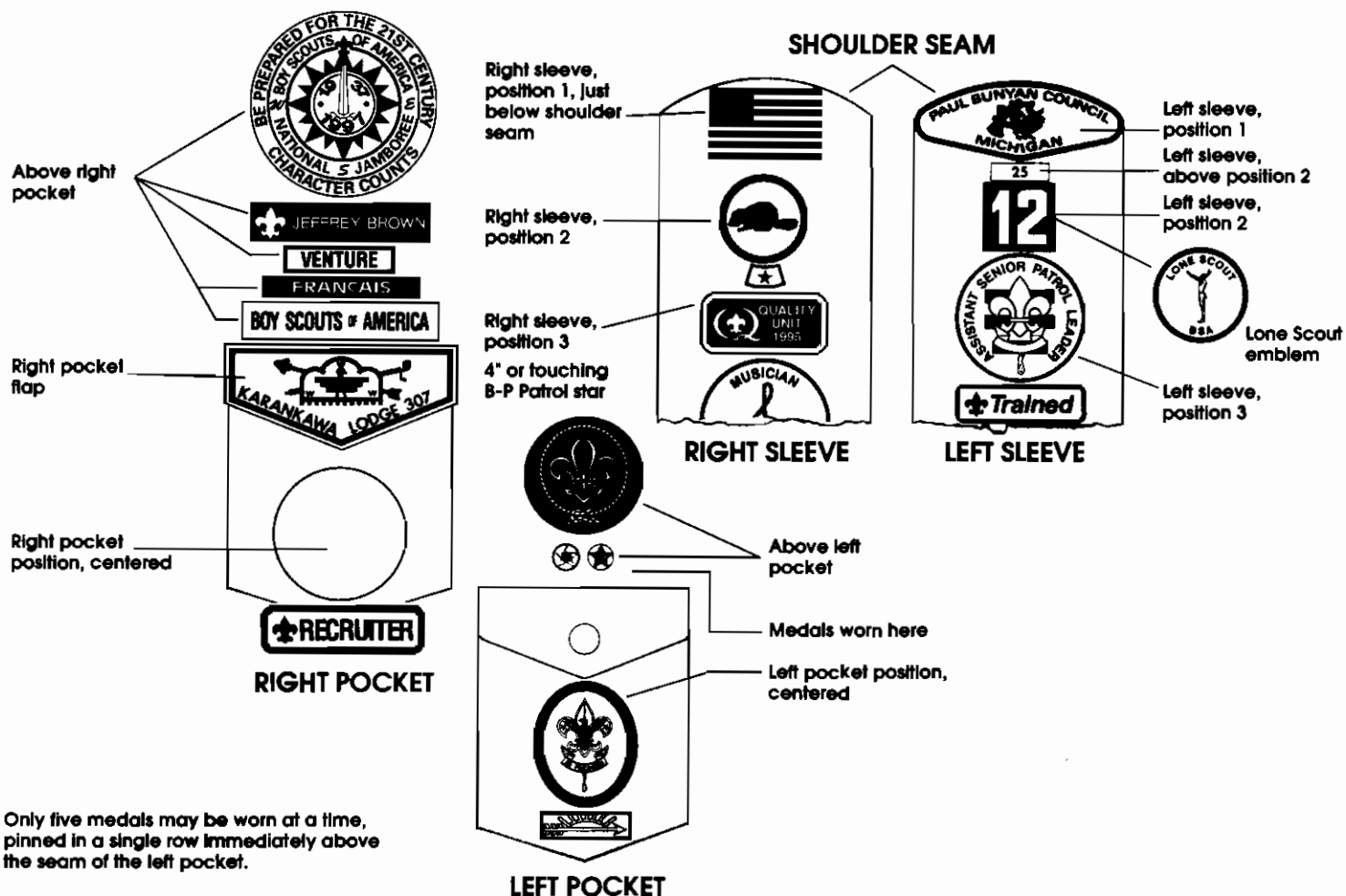

Only five medals may be worn at a time, pinned in a single row immediately above the seam of the left pocket.

BOY SCOUT PROGRAM IDENTIFICATION

U.S. flag emblem, cloth, red, white, and blue, No. 00103, Boy Scout and Boy Scout leader, right sleeve, position 1, just below shoulder seam. New uniforms have this emblem already sewn in the correct position.

Lone Scout emblem, cloth, red and black on khaki, No. 00352, Boy Scout, left sleeve, position 2.

Council shoulder emblem, cloth, No. 16xxx (last three digits, council number), Boy Scout and Boy Scout leader, left sleeve, position 1, just below shoulder seam.

Venture strip, cloth, red on tan, above Boy Scouts of America strip

or above interpreter strip. Venture, No. 00019.

Veteran unit bars, cloth, Boy Scout and Boy Scout leader, left sleeve, position 2a; 25 years, No. 00133; 50 years, No. 00105; 55 years, No. 00194; 60 years, No. 00195; 65 years, No. 00196; 70 years, No. 00197; 75 years, No. 00107; 80 years, No. 00198.

Unit number, cloth, white on red, Nos. 10400 through 10408 (last digit indicates the unit number for 0 through 8); for unit number 9, order No. 10406, Boy Scout and Boy Scout leader, left sleeve, position 2, touching council shoulder emblem if veteran unit bar is not

worn. Multiple-digit numbers may be special-ordered—2-digit, No. 10409; 3-digit, No. 10410; 4-digit, No. 10411.

Patrol emblem, cloth, 39 different emblems; blank to make your own design, No. 10240; Boy Scout, right sleeve, position 2. See specific emblem for correct number.

Order of the Arrow identification, lodge insignia fits shape of right pocket flap. Order of the Arrow membership emblem, No. 00001, suspended from right pocket button. Appropriate OA honor sash worn over right shoulder—under epaulet of tan shirt—diagonally across chest to left waist. See page 45.

PATROL EMBLEMS

(Optional for Webelos Scouts if Webelos dens are named.)



BSA emblem, cloth, No. 00320, Boy Scout and Boy Scout leader, worn on left pocket of jac-shirt and above left pocket of jacket.

Shoulder loops, colored ribbon, youth and leader, on shoulder epaulets. Troop members, red, No. 00676; Varsity Scouts in a team, blaze, No. 00681.

Bolo tie, No. 00618, Boy Scout and Boy Scout leader, worn with open-collar shirt.

World Crest, cloth, No. 00143, Boy Scout and Scouter, 3 inches below left shoulder seam and centered over pocket. May be worn by all members as an expression of world brotherhood.



Neckerchief slide, No. 00601, Boy Scout and Boy Scout leader, worn with troop neckerchief.



Scout jacket emblem



Jacket, above left pocket

Jac-shirt, on left pocket

BOY SCOUT TROOP BADGES OF OFFICE



Troop committee chairman, cloth, No. 00442, Boy Scout leader, left sleeve, position 3.



Junior assistant Scoutmaster, cloth, No. 00425, Boy Scout, left sleeve, position 3.



Scribe, cloth, No. 00430, Boy Scout, left sleeve, position 3.



Troop committee, cloth, No. 00434, Boy Scout leader, left sleeve, position 3.



Senior patrol leader, cloth, No. 00426, Boy Scout, left sleeve, position 3.



Quartermaster, cloth, No. 00431, Boy Scout, left sleeve, position 3.



Chaplain, cloth, No. 00440, clergy, left sleeve, position 3.



Assistant senior patrol leader, cloth, No. 00427, Boy Scout, left sleeve, position 3.



Librarian, cloth, No. 00432, Boy Scout, left sleeve, position 3.



Chaplain aide, cloth, gold on green, No. 00443, Boy Scout, left sleeve, position 3.



Instructor, cloth, No. 00090, Boy Scout, left sleeve, position 3.



Den chief, cloth, No. 00387, Boy Scout, left sleeve, position 3.



Scoutmaster, cloth, No. 00423, Boy Scout leader, left sleeve, position 3.



Patrol leader, cloth, No. 00428, Boy Scout, left sleeve, position 3.



Assistant Scoutmaster, cloth, No. 00424, Boy Scout leader, left sleeve, position 3.



Assistant patrol leader, cloth, No. 00429, Boy Scout, left sleeve, position 3.

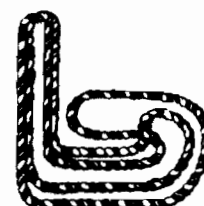

Den chief shoulder cord, cloth, blue and gold strands, No. 00388, Boy Scout, over left shoulder.

Webelos den chief shoulder cord, cloth, blue, gold, and red cords, No. 00457, Boy Scout, over left shoulder.



Bugler, cloth, No. 00433, Boy Scout, left sleeve, position 3.



Troop historian, cloth, No. 00450, Boy Scout, left sleeve, position 3.



Assistant Scoutmaster—Venture, cloth, No. 00022, Boy Scout leader, left sleeve, position 3.



Musician, cloth, No. 00449, Boy Scout, right sleeve, position 3 or below and touching Quality Unit Award. Worn only by members of troop bands or drum corps. See "Drum and Bugle Corps Uniforms" on page 4.



Troop guide, cloth, No. 00021, Boy Scout, left sleeve, position 3.



Venture crew chief, cloth, No. 00020, Boy Scout, left sleeve, position 3.

BOY SCOUT IMMEDIATE RECOGNITION

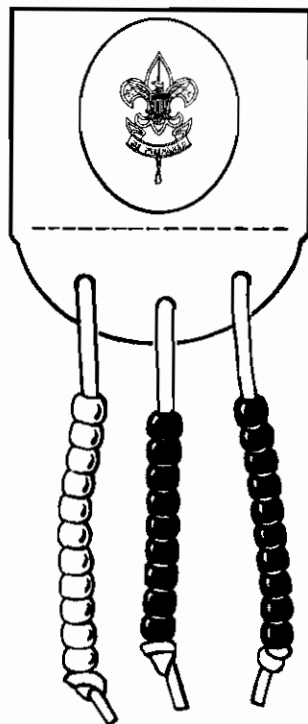

Immediate recognition kit, leather emblem with thongs and colored beads, Boy Scout, suspended on Scout belt. Individual kit, No. 00154; kit with enough for four Scouts, No. 00155.

One bead of the appropriate color is presented upon completion of a requirement for Tenderfoot, Second Class, or First Class. Scouts may wear eleven white beads for Tenderfoot, nine green beads for Second Class, and ten red beads for First Class (one bead for each requirement completed). Extra beads are included in each kit.

Beads may be earned in any sequence regardless of which rank it represents; however, the ranks must be earned in order (Tenderfoot, Second Class, then First Class).

MERIT BADGES ON REQUIRED LIST FOR EAGLE

Merit badges, required, cloth, silver border, Boy Scout, right sleeve, position 4 limited to six, merit badge sash no limit. See accompanying list of merit badges for specific number.



Camping
No. 10302



Citizenship In
the Community
No. 10303



Citizenship in
the Nation
No. 10304



Citizenship in
the World
No. 10305



Communications
No. 10306



Emergency
Preparedness
No. 10307



Environmental
Science
No. 10308



Family Life
No. 10316



First Aid
No. 10309



Lifesaving
No. 10310



Personal
Fitness
No. 10312



Personal
Management
No. 10311



Safety
No. 10313



Sports
No. 10314



Swimming
No. 10315

Temporary insignia may be worn on the back of the merit badge sash (see "Excess Insignia," page 4).

OPTIONAL MERIT BADGES

Merit badges, optional, cloth, green border, Boy Scout, right sleeve, position 4 limited to six, merit badge sash no limit. See accompanying list of merit badges for specific number.



Agribusiness
No. 10501



American
Business
No. 10502



American
Cultures
No. 10503



American
Heritage
No. 10504



American
Labor
No. 10554



Animal
Science
No. 10505



Archery
No. 10506



Architecture
No. 10507



Art
No. 10508



Astronomy
No. 10509



Athletics
No. 10510



Atomic
Energy
No. 10511



Auto
Mechanics
No. 33241



Aviation
No. 10512



Backpacking
No. 10513



Basketry
No. 10514



Bird Study
No. 10516



Bugling
No. 10518



Canoeing
No. 10519



Chemistry
No. 10520



Cinematography
No. 10521



BOY SCOUT ADVANCEMENT



Arrow of Light Award, cloth, blue on khaki, No. 00044; metal, No. 00463; Boy Scout, below left pocket, position 4.



First Class rank, cloth, gold on tan, No. 00418; large standard metal pin, No. 00017; Boy Scout, left pocket.

First Class, metal miniature, No. 00121, mother, civilian wear.



Eagle Award, silver medal suspended from scroll, No. 00135; sterling silver, No. 00112; Boy Scout. Adults wear only on formal or dress occasions.



Boy Scout badge, cloth, brown on tan, No. 00415; metal, No. 00414; Boy Scout, left pocket.

Boy Scout badge, metal miniature, No. 00116, mother, civilian wear.



Star rank, cloth, gold on tan, No. 00419; metal pin, No. 00092; Boy Scout, left pocket.

Star, metal miniature, No. 00122, mother, civilian wear.



Eagle Palm, Bronze, No. 00335; Gold, No. 00336; Silver, No. 00337; Boy Scout and Scouter, worn only on the Eagle Award ribbon or Eagle square knot. You may wear only the proper combination of Palms for the number of merit badges you earn beyond Eagle. The Bronze Palm represents five merit badges; Gold, ten; and Silver, fifteen. For example, if you earn ten merit badges and two Palms, you would wear *only* the Gold Palm. If you earn twenty merit badges and four Palms, you would wear a Silver and a Bronze Palm.



Tenderfoot rank, cloth, gold on tan, No. 00416; metal pin, No. 00010; Boy Scout, left pocket.

Tenderfoot, metal miniature, No. 00119, mother, civilian wear.



Life rank, cloth, gold and red on tan, No. 00420; metal pin, No. 00091; Boy Scout, left pocket.

Life, metal miniature, No. 00123, mother, civilian wear.



Second Class rank, cloth, gold on tan, No. 00417; metal pin, No. 00014; Boy Scout, left pocket.

Second Class, metal miniature, No. 00120, mother, civilian wear.



Eagle rank, cloth, silver, white, and blue on red, No. 00489, Boy Scout, left pocket. Adults wear square knot.



Eagle, metal miniature, No. 00124; sterling silver, No. 00024; tie tack, sterling silver, No. 00025. Boy Scout or his mother, civilian wear.

Eagle square knot, cloth, red, white, and blue on tan, No. 05011, Scouter, above left pocket. Boy Scouts wear Eagle rank, No. 00489.

BOY SCOUT PARTICIPATION AND ACHIEVEMENT



Attendance pin and 1-year bar, No. 00051, Boy Scout, above left pocket; 2-year bar, No. 00052; 3-year bar, No. 00053; 4-year bar, No. 00054; 5-year bar, No. 00055; 6-year bar, No. 00056; 7-year bar, No. 00057; 8-year bar, No. 00058; 9-year bar, No. 00059; 10-year bar, No. 00060; Boy Scout, attached to attendance pin.



Baden-Powell Patrol star, cloth, No. 00367, Boy Scout, beneath patrol emblem of patrol that has met the standard.

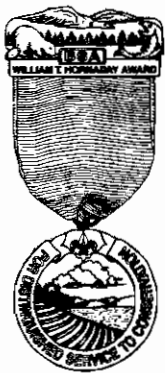

Hornaday Award, bar pin, ribbon, pendant, and embroidered blue, green, and white knot, Boy Scout, above left pocket; Hornaday badge, bar pin, Boy Scout, above left pocket.



High adventure emblem, cloth, No. 00190; leather, No. 00242; hat pin, No. 00995; decal, No. 33475; Boy Scout and Scouter, equipment decoration.



Philmont Scout Ranch, cloth, arrowhead with Tooth of Time, Boy Scout or Scouter, right pocket.



High-adventure bases, cloth, Florida High Adventure Sea Base; Northern Tier National High Adventure Programs; Charles L. Sommers High Adventure Base; and Northern Wisconsin High Adventure Base; Boy Scout and Scouter, jac-shirt right pocket.



Recruiter strip, cloth, No. 00219, Boy Scout, below right pocket.

ITALIANO

Interpreter strips, cloth, French, No. 00391; German, No. 00392; Spanish, No. 00395; signing for deaf, No. 00390; other language, No. 00396; Boy Scout and Scouter, above right pocket.



50-Miler Award, cloth, No. 00187; leather, No. 00243; Boy Scout and Scouter, equipment decoration.



Historic Trails, cloth, No. 00188; leather, No. 00244; Boy Scout and Scouter, equipment decoration.



Paul Bunyan Woodsman, cloth, No. 00098, Boy Scout, equipment decoration.



Mile Swim, BSA, cloth, No. 00245, Boy Scout, left side of swim trunks.



Snorkeling, BSA, cloth, No. 00248, Boy Scout, left side of swim trunks.



BSA Lifeguard, cloth, No. 00132, Boy Scout, right side of swim trunks.



BSA Aquatics Instructor, No. 00148, Scouter, worn on right side of swim trunks.



Boy Scout World Conservation Award, cloth, No. 00140, Boy Scout, right pocket.



Quality Unit, cloth, youth member and leader, right sleeve, position 3 (4 inches below seam or, if Baden-Powell Patrol star is worn, touching it). Only the most recently earned Quality Unit emblem may be worn. See your local council for current item number.

Sports pins: Basketball, No. 02702; Bowling, No. 02694; Shooting Sports, No. 02703; Soccer, No. 02704; Softball, No. 02705; Swimming, 02695; Tennis, No. 02706; Triathlon, No. 02707; Volleyball, No. 02708; Waterskiing, No. 02696.

Varsity pins: Cross Country Skiing, No. 02709; Roller Hockey, No. 02693; Varsity gold bar, No. 02701. **Uniform strips,** Varsity, No. 00018; Venture, No. 00019.



Contest medal, with red and white ribbon, Boy Scout, above left pocket; Bronze, No. 00937; Silver, No. 00938; Gold, No. 00939.

Den Chief Service Award, red, white, and blue shoulder cord, No. 00389, Boy Scout who has met high standards of service, over left shoulder.



Venture letter, cloth, No. 00047; Venture crew member in a troop, worn on right breast of jacket or bottom front of the merit badge sash.

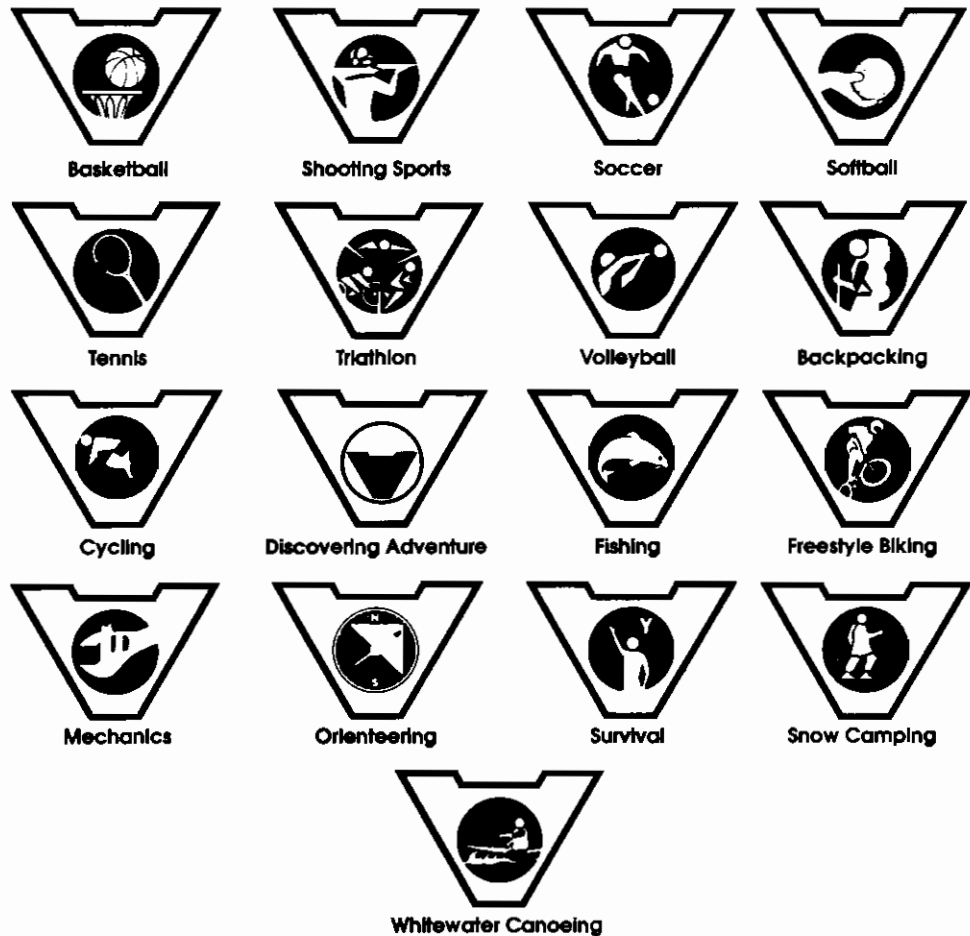

Venture activities pins: Backpacking, No. 02710; Canoe Camping, No. 02697; Caving, No. 02698; Cycling, No. 02712; Discovering Adventure, No. 02713; Fishing, No. 02714; Freestyle Biking, No. 02715; Frontiersman, No. 02699; Mechanics, No. 02716; Orienteering, No. 02717; Rock Climbing and Rappelling, No. 02700; Snow Camping, No. 02711; Survival, No. 02718; Whitewater Canoeing, No. 02719; Venture crew member, worn on Venture letter.

RELIGIOUS EMBLEMS

Boy Scout religious emblems consist of a bar pin, ribbon, and pendant. All are worn above the left pocket. (See the drawing on page 44.)



**Ad Altare Dei
Roman Catholic**



**Alpha Omega
Eastern Orthodox**



**Ararat
Eastern Diocese of the
Armenian Church
of America**



**Compassionate Father
Meher Baba**



**God and Country
Baptist**



**God and Country
God and Church
Episcopal**



**God and The
Salvation Army**



**God and Country
(Bog i Ojczyzna)
Polish National
Catholic Church**



**God and Country
God and Church
Methodist**



**God and Country
God and Church
Presbyterian**



**God and Country
First Church of Christ
Scientist**



**God and Country
God and Church
Christian Church
(Disciples of Christ)**



**God and Country
God and Church
Protestant**



**God and Country
Moravian**



**Good Life
Zoroastrian**



**Good Servant
Churches of Christ**



**In the
Name of God
Islamic**



Liahona (Compass)
Reorganized Church
of Jesus Christ of
Latter Day Saints



Light is Life
Eastern Rite
Catholic



Light of God
Association of Unity Churches



Ner Tamid
Jewish



God and Church
Lutheran

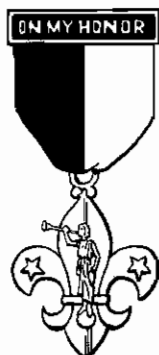

On My Honor
Church of Jesus Christ
of Latter-day Saints



Open Word
General Church of the
New Jerusalem



Religion in Life
Unitarian Universalist



Saint Mesrob
Armenian Apostolic Church
of America
(Western Prelacy)



Sangha
Buddist



Spirit of Truth
Religious Society of Friends
(Quakers)



Unity of Mankind
Baha'i

TRAINING RECOGNITIONS



Scoutmaster's Key, green ribbon with broad white stripe and pendant, No. 00924; embroidered square knot, green and white knot, green to right, No. 05006, above left pocket, key or embroidered square knot may be worn; Scoutmaster device, metal universal emblem, No. 00927, worn on ribbon of Scoutmaster's Key and/or knot. The Varsity Scout device is No. 00928.



Wood Badge slide or woggle, No. 02173, trained Scouter, with Wood Badge neckerchief; necklace with two beads, No. 02175; three beads, No. 02176; four beads, No. 02177; worn under Wood Badge neckerchief, and over the ends below the woggle, with official field uniform; Wood Badge beads are not worn on civilian clothes, dress blazer uniform, or with a T-shirt.



Trained Leader emblem, No. 00280, is available for all leaders who have completed the basic training program appropriate to their positions. The emblem is worn immediately below and touching the emblem of office for which it was earned. Boy Scout junior leaders who have completed troop junior leader training and den chiefs who have completed the den chief training conference may wear the Trained Leader emblem beneath their badge of office.

Note: The Trained Leader emblem may be worn *only* in connection with the emblem of office for which basic training has been completed.



Junior leader training, cloth, No. 00096, Boy Scout, right pocket; hat pin, No. 00089.



Boy Scout Leader's Training Award, green ribbon with narrow white stripe and pendant, No. 00922; embroidered square knot, green knot on tan, No. 05008, above left pocket, award or embroidered square knot may be worn; Boy Scouting device, metal universal emblem, No. 00927, worn on ribbon of Boy Scout Leader's Training Award and/or knot. The Varsity Scout device is No. 00928.



National Junior Leader Instructor Camp—Philmont, cloth, Boy Scout, right pocket.

Varsity Scout Insignia

VARSITY SCOUT TEAM BADGES OF OFFICE

Committee chairman, cloth, No. 02727; Varsity Scout leader, left sleeve, position 3 of official uniform shirt.

Team committee, cloth, No. 02726; Varsity Scout leader, left sleeve, position 3 of official uniform shirt.

Team coach, cloth, No. 02723; Varsity Scout leader, left sleeve, position 3 of official uniform shirt.

Assistant team coach, cloth, No. 02724; Varsity Scout leader, left sleeve, position 3 of official uniform shirt.

Note: The Varsity Scout uniform is the official field uniform of the Boy Scouts of America with distinctive blaze-color shoulder loops. Varsity Scouts in a troop wear red shoulder loops and Varsity strip (see page 16). The Varsity Scout jacket and the Varsity Scout cap may be worn with the Varsity Scout uniform. For placement of insignia on the field uniform, see page 16. Varsity Scouts may also wear the Varsity activity uniform which consists of activity shirt, shorts, and socks.

Team captain, cloth, No. 02721; Varsity Scout, left sleeve, position 3 of official uniform shirt.

Team cocaptain, cloth, No. 02722; Varsity Scout, left sleeve, position 3 of official uniform shirt.

Program manager, cloth, No. 02725; Varsity Scout, left sleeve, position 3 of official uniform shirt.

Squad leader, cloth, No. 02720; Varsity Scout, left sleeve, position 3 of official uniform shirt.

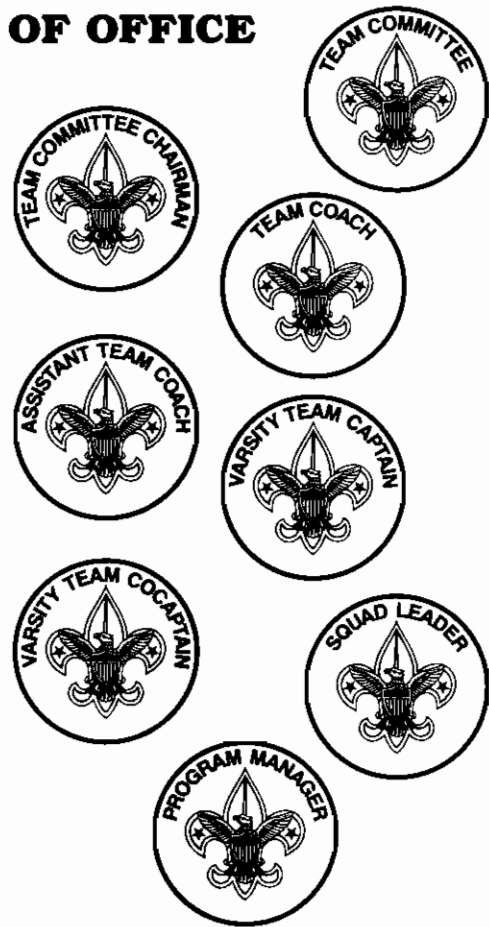

VARSITY SCOUT PROGRAM IDENTIFICATION

Varsity Scout shoulder loop, cloth, blaze, No. 00681, Varsity Scout and Varsity Scout leader, worn on official uniform shirt. Varsity Scouts in a troop wear red shoulder loops.



Varsity jacket emblem, No. 00321; gold bar, No. 02701; Varsity strip, No. 00018.



VARSITY SCOUT LETTER



Varsity Scout letter, cloth No. 00047; Varsity Scout, worn on right breast of jacket or bottom front of the merit badge sash.

Explorer Insignia

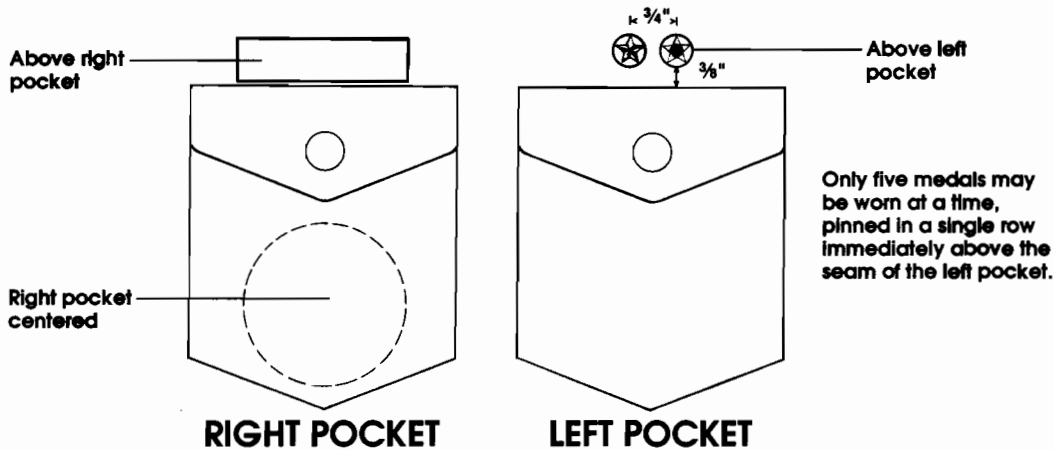
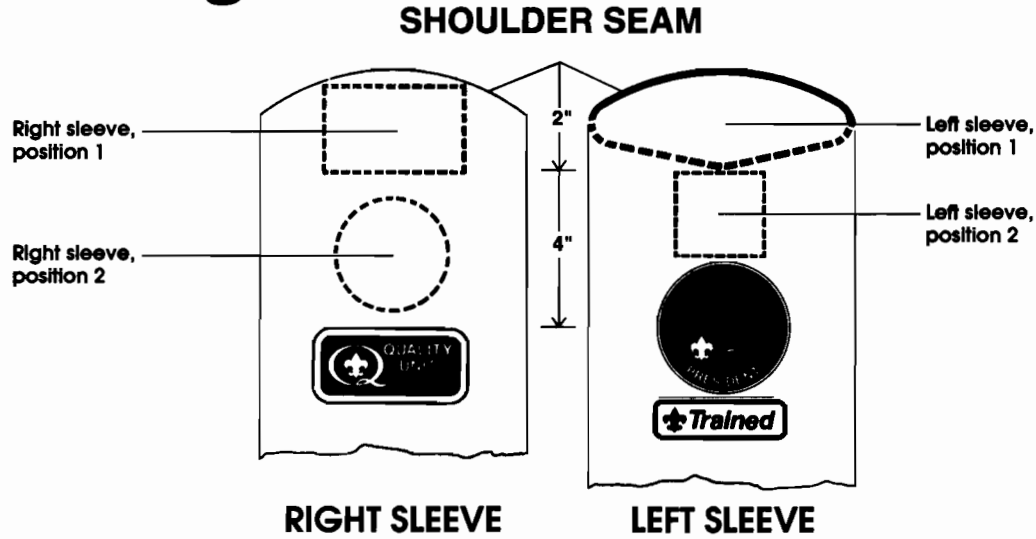

EXPLORER PROGRAM IDENTIFICATION

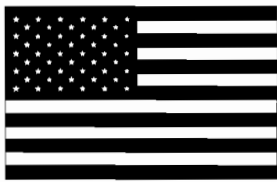

U.S. flag emblem, cloth, red, white, and blue, No. 00103, Explorer and Explorer leader, right sleeve. New uniforms have this emblem already sewn in the correct position.



Explorer E jacket emblem



Aviation Exploring emblem, cloth, No. 04011, Explorer jacket or Explorer specialty uniform, right sleeve, position 2.



Law Explorer emblem, cloth, No. 04013. Explorer jacket or Explorer specialty uniform, right sleeve, position 2.



Explorer E lapel pin

Explorer E, cloth, No. 04002. Explorer jacket, above left pocket; lapel pin, No. 04001. Explorer, civilian wear.

Shoulder loops, green ribbon, No. 00678, Explorer and Explorer leader, on shoulder epaulets.

Unit number, cloth, white on red, Nos. 10400 through 10408 (last digit indicates the unit number for 0 through 8); for unit number 9, order No. 10406. Explorer or Explorer leader wearing traditional uniform, left sleeve, position 2, touching council shoulder patch. Multiple-digit numerals may be special-ordered—2-digit, No. 10409; 3-digit, No. 10410; 4-digit, No. 10411.



Outdoor Adventure emblem, cloth, No. 04162, Explorer jacket or Explorer specialty uniform, right sleeve, position 2.



Fire Emergency emblem, cloth, No. 04174, Explorer jacket or Explorer specialty uniform, right sleeve, position 2.



Law Enforcement emblem, cloth, No. 04016, Explorer jacket or Explorer specialty uniform, right sleeve, position 2; lapel pin, No. 04113, Explorer, civilian wear.



Sea Exploring Affiliation emblem, cloth, No. 04066, Sea Explorer jacket or Explorer specialty uniform, right sleeve, position 2.



Airport Management



Mechanic



Flight Attendant



Ground Support

Aviation Exploring recognition wings, cloth, worn on Aviation Explorer specialty uniform, above left pocket. Airport Management, No. 04046; Mechanic, No. 04047; Flight Attendant, No. 04048; Ground Support, No. 04049.

The recognition wings are to be worn by Explorers whose post specializes in airport management, aircraft mechanics, ground support, or flight attending, or Explorers who have gone through an orientation or training course related to the specialty as determined by the post.



Law Enforcement Explorer proficiency ribbons. For wear on law enforcement security uniforms. Law Enforcement Training, red and blue, No. 04018; Community Service, blue and yellow, No. 04019; Crime Prevention, green and gold, No. 04020; Law Enforcement Service, red and gold, No. 04021; Emergency Preparedness, red and white, No. 04022; Tenure, red, No. 04023; Perfect Attendance, yellow and white, No. 04024; Explorer of the Year, blue with Explorer "E," No. 04025; and Drug Abuse Prevention, blue and gray, No. 04026. The color mentioned first is worn to wearer's right, rows of three, above left pocket. Wear ribbons using single-ribbon holder, No. 04027; double-ribbon holder, No. 04028; and/or triple-ribbon holder, No. 04029.

Note: For more information, request *Law Enforcement Explorer Proficiency Awards Program*, No. 23-213, from Exploring Division, S210, Boy Scouts of America, 1325 West Walnut Hill Lane, P.O. Box 152079, Irving, TX 75015-2079.

Sea Explorer Insignia

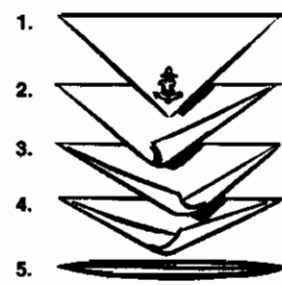
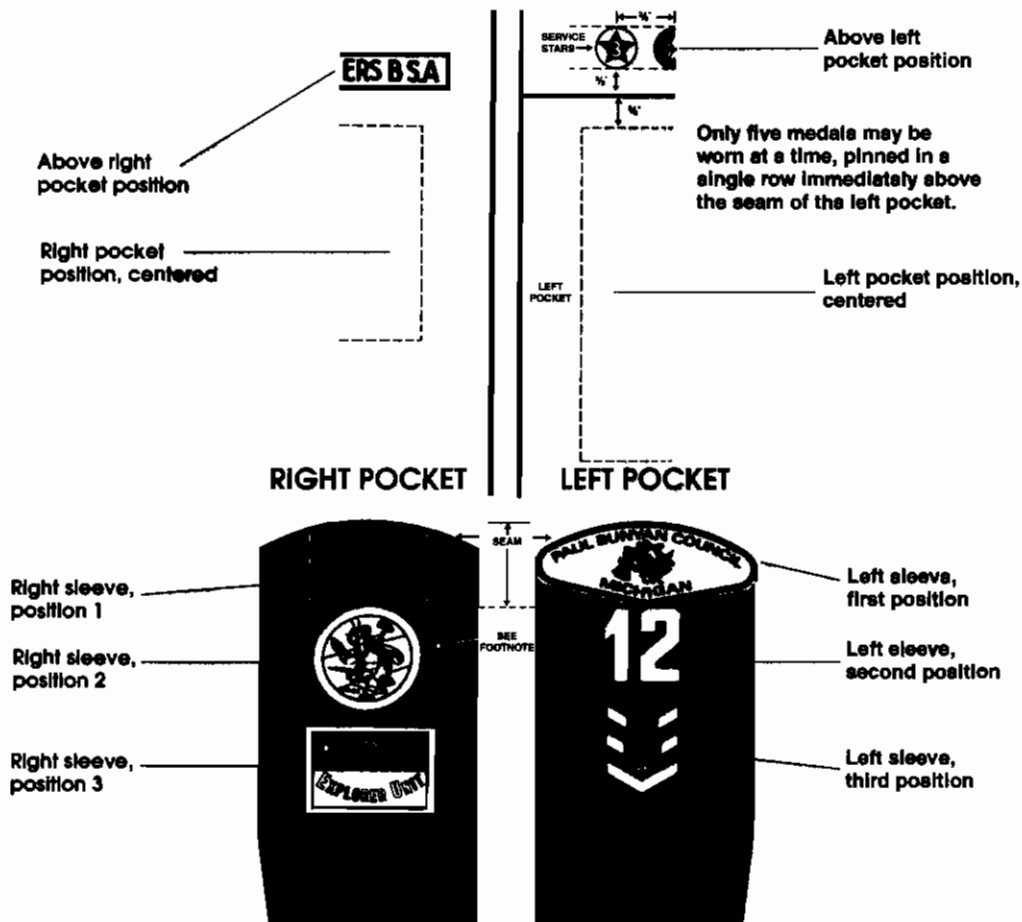

Sea Explorer neckerchief or cravat special order, No. 04153

BADGES 1/2" APART BELOW SHIP MEDALLION AND NUMBER

RIGHT SLEEVE

LEFT SLEEVE



Sea Exploring emblem, blue cloth, No. 04119; white cloth, No. 04120, Sea Explorer, right sleeve, position 2.



for leader's cap; metal miniature, No. 04135, Sea Explorer and leader, civilian wear.



Sea Exploring cap button, silver, small, No. 04156, worn on Sea Exploring leader's cap.



Sea Exploring coat button, silver, large, No. 04155, worn on Sea Exploring leader's coat.



Sea collar ornaments, white cloth, No. 04146; blue cloth, No. 04147, Sea Explorer, corners of the jumper collar.

Sea Explorer leader hatband, No. 04154.



Sea Explorers, BSA, blue cloth, No. 04125; white cotton cloth, No. 04126; red letters on tan cloth, No. 04127; Sea Explorer, above right pocket.

Sea Explorer insignia, miniature, No. 04134, Sea Explorer leader, placed on front of braid extension



Sea Explorer emblem, white cloth with gold E, No. 04054; blue cloth, No. 04067; white cloth with blue E, No. 04068; Sea Explorer.

Sea Explorer ship numbers, blue cloth, ship numbers 0 to 8, Nos. 04074 to 04082, respectively; white cloth, ship numbers 0 to 8, Nos. 04084 to 04092, respectively; Sea Explorer, left sleeve, position 2.



Sea Explorer pin, metal, No. 04094, Explorer, civilian wear.

SEA EXPLORER ADVANCEMENT



Apprentice badge of rank, blue cloth, No. 04142; white cloth, No. 04145; Sea Explorer, left pocket.



Able badge of rank, blue cloth, No. 04140; white cloth, No. 04143; Sea Explorer, left pocket.



Quartermaster Award, ribbon and pendant, No. 04148, Sea Explorer, left pocket; patch, No. 04100, Sea Explorer, right pocket, embroidered knot, blue on white, No. 05009, Scouter, above left pocket; miniature, No. 04051, Sea Explorer, civilian wear.



Ordinary badge of rank, blue cloth, No. 04141; white cloth, No. 04144; Sea Explorer, left pocket.



Quartermaster badge of rank, blue cloth, No. 04121; white cloth, No. 04122; Sea Explorer, both sleeve cuffs. Adults wear square knot.



Small-boat handler, metal, No. 04052, Sea Explorer, left pocket.



Qualified seaman, metal, No. 04053, Sea Explorer, left pocket.

EXPLORING AND SEA EXPLORING BADGES OF OFFICE



Post committee, cloth, No. 04045, Explorer leader, left sleeve, position 3.



Treasurer, cloth, No. 04041, Explorer, left sleeve, position 3.



Vice president, cloth, No. 04037, Explorer, left sleeve, position 3.



Advisor, cloth, No. 04031, Explorer leader, left sleeve, position 3.



President, cloth, No. 04035, Explorer, left sleeve, position 3.



Associate Advisor, cloth, No. 04033, Explorer leader, left sleeve, position 3.



Secretary, cloth, No. 04039, Explorer, left sleeve, position 3.



Skipper, blue cloth, No. 04095; white cloth, No. 04096; Sea Explorer leader, both sleeve cuffs.



Boatswain, blue cloth, No. 04062; white cloth, No. 04063; Sea Explorer, left sleeve, position 3.



Boatswain's mate, blue cloth, No. 04060; white cloth, No. 04061; Sea Explorer, left sleeve, position 3.



Purser, blue cloth, No. 04069; white cloth, No. 04070; Sea Explorer, left sleeve, position 3.



Ship committee member/mate, cloth, one star, blue, No. 04098; white, No. 04099; ship Sea Exploring leader, both sleeve cuffs.



Crew leader, blue cloth, No. 04058; white cloth, No. 04059; Sea Explorer, left sleeve, position 3.



Storekeeper, blue cloth, No. 04064; white cloth, No. 04065; Sea Explorer, left sleeve, position 3.



Specialist, blue cloth, No. 04072; white cloth, No. 04073; Sea Explorer, left sleeve, position 3.



Yeoman, blue cloth, No. 04123; white cloth, No. 04124; Sea Explorer, left sleeve, position 3.



Bugler, blue cloth, No. 04150; white cloth, No. 04151; Sea Explorer, left sleeve, position 3.

EXPLORER PARTICIPATION AND ACHIEVEMENT

50-Miler Award, cloth, No. 00187; leather, No. 00243; Explorer, equipment decoration.

Historic Trails Award, cloth, No. 00188; leather, No. 00244; Explorer, equipment decoration.

Mile Swim, BSA, cloth, No. 00245, Explorer, left side of swim trunks.

BSA Lifeguard, cloth, No. 00132, Explorer, left side of swim trunks.

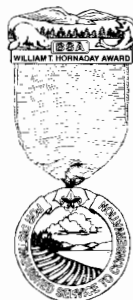

Hornaday Award, bar pin, ribbon, and pendant, Explorer, above left pocket; Hornaday badge, bar pin, Explorer, above left pocket. Available only through Boy Scout Division.



Explorer Achievement Award, lapel pin, No. 04159, civilian wear; cloth, silver knot on red, white, and blue background (red to wearer's right), No. 05526, above left pocket.



High adventure emblem, cloth, No. 00190; leather, No. 00242, Explorer, equipment decoration.



Philmont Scout Ranch, cloth, arrowhead with Tooth of Time, Explorer, right pocket.



Philmont bull, worn on left side of jac-shirt above pocket.



Long Cruise badge, white cloth, No. 04136; blue cloth, No. 04139, Sea Explorer and Advisor, left sleeve, position 4; Long Cruise arc, red cloth, No. 04137; white cloth, No. 04138.



High-adventure bases, cloth, Florida National High Adventure Sea Base; Northern Tier National High Adventure Programs; Charles L. Sommers High Adventure Base; and Northern Wisconsin High Adventure Base; Explorer and leader, jac-shirt right pocket.



Standard Explorer unit, cloth, No. 17549, Sea Explorer and Skipper, right sleeve, position 3.



Explorer officers' association, cloth emblem, No. 04175, Explorer, centered on left pocket of jacket; metal pins, No. 04176, Explorer, civilian wear.



Quality Unit, cloth, youth member and leader, right sleeve, position 3. See your local council for specific year numbers. Only the most recently earned Quality Unit emblem may be worn.

RELIGIOUS EMBLEMS



Religious emblem square knot, cloth, silver knot on purple, No. 05007, youth member or Scouter, above left pocket; cloth, purple knot on silver, No. 05014, Scouter only, above left pocket. See note on page 45.



Pope Pius XII, Roman Catholic, bar pin, ribbon, and medal, Explorer, above left pocket.



Living Faith Lutheran



Salvation Army



God and Country
God and Life
Protestant

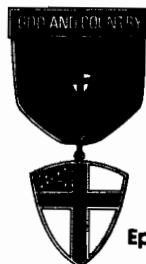

Episcopal

God and Country—God and Life, Episcopal, miniature for God and Country ribbon; Protestant, bar pin, green ribbon, and medal, miniature for God and Country ribbon, Salvation Army, bar pin and medal; Explorer, above left pocket.



Life and World—World Community, Reorganized Church of Jesus Christ of Latter Day Saints, device worn on ribbon, Explorer, above left pocket.

Notes: 1. See also pages 25–26.
2. For additional information on religious emblems, write for Religious Emblems Programs flier, No. 5-206A, from the Relationships Division, S226, Boy Scouts of America, 1325 West Walnut Hill Lane, P.O. Box 152079, Irving, TX 75015-2079.

TRAINING RECOGNITIONS



Skipper's Key, green ribbon with broad white stripe, pendant, No. 00924. Trained Sea Exploring Skipper wears pendant with Skipper device, No. 00931. Device may also be worn on embroidered square knot (see note on page 45).

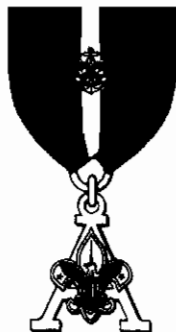

Sea Explorer Leader's Training Award, green ribbon with narrow stripe, pendant, No. 00922. Trained Sea Explorer leader wears pendant with Sea Exploring device, No. 00931. Device may also be worn on embroidered square knot (see note on page 45).



Sea badge, pin, restricted, No. 04097, presented by a region to a fully trained Sea Exploring leader, civilian wear only. A knot, No. 05527, is also available.



Trained Leader emblem, No. 00280, is available for all leaders who have completed the basic training program appropriate to their positions. The emblem is worn immediately below and touching the emblem of office for which it was earned. Elected Explorers who have completed the post officers' seminar may wear the Trained Leader emblem beneath their badge of office.



Exploring Training Award, metal, No. 04117, Exploring leaders, civilian wear.



Exploring Key, metal, No. 04116, trained Advisor or service team member, civilian wear.

Note: The Trained Leader emblem may be worn *only* in connection with the emblem of office for which basic training has been completed.

Universal and Nonunit Insignia

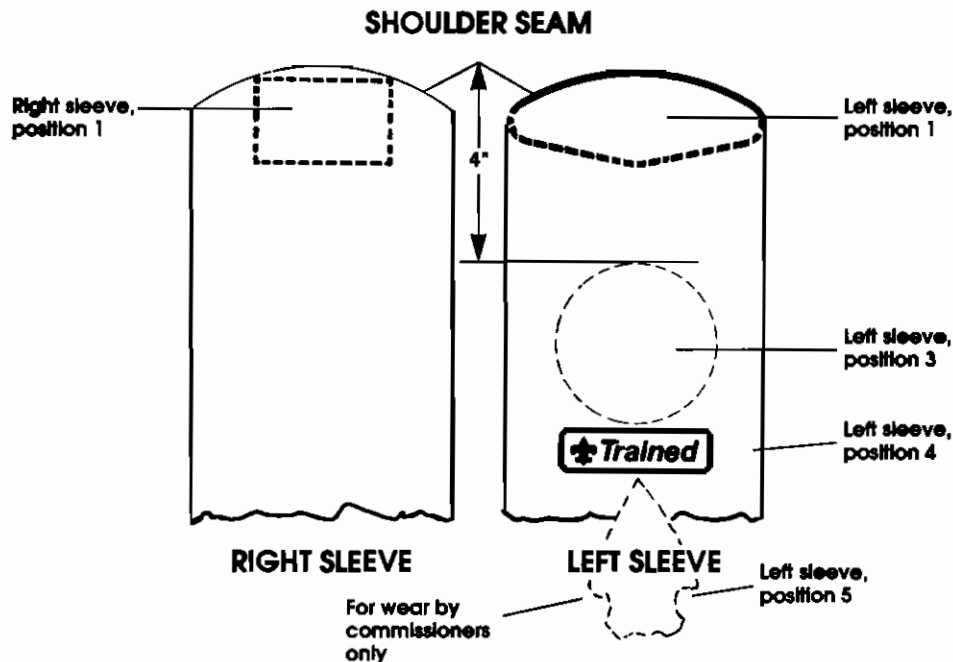

IDENTIFICATION

U.S. flag emblem, cloth, red, white, and blue, No. 00103, Scouter, right sleeve, position 1. New uniforms have this emblem already sewn in the correct position.

Universal lapel pin, No. 00114; sterling silver, No. 00099; silver tone, No. 00101. Scouter, civilian wear.

Shoulder loops, silver ribbon, No. 00680, council or district Scouter; gold ribbon, No. 00679, national or regional Scouter, on shoulder epaulets. Wear the color for the position in which you are functioning.

Council shoulder emblem, cloth, No. 16xxx (last three digits, council number); Scouter, left sleeve, position 1.

NATIONAL AND REGIONAL BADGES OF OFFICE



National president, restricted, national Scouter, left sleeve, position 3.

National past president, restricted, national Scouter, left sleeve, position 3.

National vice-president, restricted, national Scouter, left sleeve, position 3.



National commissioner, restricted, national Scouter, left sleeve, position 3.



International commissioner, restricted, national Scouter, left sleeve, position 3.



Chief Scout Executive, restricted, national Scouter, left sleeve, position 3.



National Executive Board, restricted, national Scouter, left sleeve, position 3.



National executive staff, No. 00284, national Scouter, left sleeve, position 3.



National Committee, restricted, national Scouter, left sleeve, position 3.



National partner representative, national Scouter, left sleeve, position 3. Available on a restricted basis through the Relationships Division at the national office.



National Sea Exploring Committee, cloth, four stars; blue, No. 04132; white, No. 04133; national Sea Exploring leader, both sleeve cuffs.



Sea Exploring regional/area committee, cloth, three stars; blue, No. 04130; white, No. 04131; regional/area Sea Exploring leader, both sleeve cuffs.



Regional president, No. 00263, regional Scouter, left sleeve, position 3.



Regional committee, No. 00264, regional Scouter, left sleeve, position 3.



Area president, No. 00265, area Scouter, left sleeve, position 3.



Area committee, No. 00266, area Scouter, left sleeve, position 3.



Ambassador, restricted, national Scouter, left sleeve, position 3.

COUNCIL BADGES OF OFFICE



Council president, No. 00447, council Scouter, left sleeve, position 3.

Council past president, No. 00448, council Scouter, left sleeve, position 3.

Council vice-president, No. 00268, council Scouter, left sleeve, position 3.



Council commissioner, No. 00438, council Scouter, left sleeve, position 3.



Council executive board, No. 00446, council Scouter, left sleeve, position 3.



Council committee, No. 00445, council Scouter, left sleeve, position 3.



International representative, No. 00141, council Scouter, left sleeve, position 3.



Chartered organization representative, No. 00490, council Scouter, left sleeve, position 3.



Sea Exploring council committee, cloth. two stars; blue, No. 04128; white, No. 04129; council Sea Explorer leader, both sleeve cuffs.



Cub Scout roundtable staff, No. 00130. district Scouter, left sleeve, position 3.



Exploring service team, cloth, No. 04043. District or division Scouter, left sleeve, position 3.



District committee, No. 00444. district Scouter, left sleeve, position 3.



Boy Scout roundtable commissioner, No. 00344. district Scouter, left sleeve, position 3.



Exploring service team pin, No. 04152. district or division Scouter, civilian wear.



District commissioner, No. 00436. district Scouter, left sleeve, position 3.



Boy Scout roundtable staff, No. 00131. district Scouter, left sleeve, position 3.



Unit commissioner, No. 00435. district Scouter, left sleeve, position 3.

Assistant district commissioner, No. 00437. district Scouter, left sleeve, position 3.



District chairman, No. 00267. district Scouter, left sleeve, position 3.



Varsity Scout huddle commissioner, cloth, No. 00104. district Scouter, left sleeve, position 3.



Chaplain, No. 00440. council Scouter, left sleeve, position 3.



Cub Scout roundtable commissioner, No. 00340. district Scouter, left sleeve, position 3.



Varsity Scout huddle staff, cloth, No. 00134. district Scouter, left sleeve, position 3.



Physician, No. 00441. council Scouter, left sleeve, position 3.

EMPLOYED PERSONNEL BADGES OF OFFICE



Scout executive, No. 00295. council Scouter, left sleeve, position 3.



District executive, No. 00293. council Scouter, left sleeve, position 3.



District director, No. 00288. council Scouter, left sleeve, position 3.



Council executive staff, No. 00292. council Scouter, left sleeve, position 3.



District executive staff, No. 00294. council Scouter, left sleeve, position 3.



Senior district executive, No. 00289. council Scouter, left sleeve, position 3.



Retired, emblem strip, No. 00281.

Paraprofessional, No. 00287. council Scouter, left sleeve, position 3.



Exploring executive, No. 00291. council Scouter, left sleeve, position 3.

Employee, No. 00253. council Scouter, left sleeve, position 3.

Ranger, No. 00254. council Scouter, left sleeve, position 3.

Assistant ranger, No. 00250. council Scouter, left sleeve, position 3.



Senior Exploring executive, No. 00290. council Scouter, left sleeve, position 3.

SERVICE STARS



Orange backs for Stars, No. 00062. youth Tiger Cub service, above left pocket.

Gold backs for Stars, No. 00063. youth Cub Scout service, above left pocket.

Green backs for Stars, No. 00066. youth Boy Scout service, above left pocket.

Brown backs for Stars, No. 00067. youth Varsity Scout service, above left pocket.

Red backs for Stars, No. 00065. youth Explorer service, above left pocket.

Blue backs for Stars, No. 00064. adult Scouter service, above left pocket.

1-year service star, No. 00071. all members, above left pocket.

2-year service star, No. 00072. all members, above left pocket.

3-year service star, No. 00073. all members, above left pocket.

4-year service star, No. 00074. all members, above left pocket.

5-year service star, No. 00075. Boy Scout, Explorer, or Scouter, above left pocket.

6-year service star, No. 00076. Boy Scout, Explorer, or Scouter, above left pocket.

7-year service star, No. 00077. Boy Scout, Explorer, or Scouter, above left pocket.

8-year service star, No. 00078. Scouter, above left pocket.

9-year service star, No. 00079,
Scouter, above left pocket.

10-year service star, No. 00080,
Scouter, above left pocket.

20-year service star, No. 00068,
Scouter, above left pocket.

30-year service star, No. 00069,
Scouter, above left pocket.

40-year service star, No. 00070,
Scouter, above left pocket.

50-year service star, No. 00081,
Scouter, above left pocket.

60-year service star, No. 00082,
Scouter, above left pocket.

70-year service star, No. 00083,
Scouter, above left pocket.

Notes: 1. Service stars may be worn by all youth and adult members who have at least one year of tenure with the Boy Scouts of America. The stars are worn with the appropriate color background for the phase of Scouting the service was rendered. If an individual's primary registration is in one phase of Scouting and later in another, separate

stars with the appropriate background and numerals may be worn simultaneously. Or, leaders may combine youth and adult tenure into one or two stars with blue background.
2. If a medal or embroidered knot is worn, service stars are worn $\frac{1}{2}$ inch above the medal or knot.

VETERAN RECOGNITIONS



5-year veteran pin, No. 00970,
youth member or Scouter, civilian
wear only.

10-year veteran pin, No. 00286,
Scouter, civilian wear only.

15-year veteran pin, No. 00189,
Scouter, civilian wear only.

20-year veteran pin, No. 00314,
Scouter, civilian wear only.

25-year veteran pin, No. 00113,
Scouter, civilian wear only.

30-year veteran pin, No. 00126,
Scouter, civilian wear only.

35-year veteran pin, No. 00038,
Scouter, civilian wear only.

40-year veteran pin, No. 00004,
Scouter, civilian wear only.

45-year veteran pin, No. 00005,
Scouter, civilian wear only.

50-year veteran pin, gold, No.
00006, Scouter, civilian wear only.

55-year veteran pin, No. 00969,
Scouter, civilian wear only.

60-year veteran pin, No. 00003,
Scouter, civilian wear only.

65-year veteran pin, No. 00977,
Scouter, civilian wear only.

70-year veteran pin, No. 00971,
Scouter, civilian wear only.

75-year veteran pin, with dia-
mond, No. 00973, Scouter, civilian
wear only.

RECOGNITIONS



Organizer pin, No. 00097,
Scouter, civilian wear.

Thanks pin, No. 00109, Scouter,
civilian wear.

Silver Beaver Award, blue and
white ribbon and pendant, No.
00331, council Scouter for distin-



guished service, formal wear as
illustrated; silver charm, No.
00665, civilian wear; lapel pin, No.
00033, civilian wear; lapel pin with
diamond, No. 00200; embroidered
blue and white knot, blue to right,
No. 05003, above left pocket.

Silver Antelope Award, gold
and white ribbon and pendant, No.

00322, regional Scouter for distin-
guished service, formal wear as
illustrated; silver charm, No.
00666, civilian wear; lapel pin, No.
00034, civilian wear; lapel pin with
diamond, No. 00201; embroidered
gold and white knot, gold to right,
No. 05005, above left pocket.



Silver Buffalo Award, red and white ribbon and sterling silver pendant, No. 00324, national Scouter for distinguished service, formal wear as illustrated; silver



charm, No. 00671, civilian wear; lapel pin, No. 00035, civilian wear; lapel pin with diamond, No. 00202; embroidered red and white knot, red to right, No. 05004, above left pocket.



Distinguished Eagle Scout Award, red, white, and blue ribbon and pendant, No. 00330, Scouter, formal wear as illustrated; miniature pin, No. 00094, on Eagle knot; lapel pin, No. 00328; charm, No. 00652, for wife.



Whitney M. Young Jr. Service Award, presentation plaque, lapel pin, and knot, volunteer who has made an outstanding contribution through Scouting to low-income urban/rural youth. Award also granted to organizations, but the lapel pin is worn only by those who have received the award in their own name, not as a member of a group, organization, or corporation. Civilian wear. Available on a restricted basis from Council Services Division at the national office.

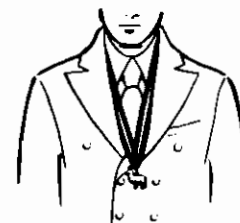

How to wear ribbon and pendant awards



Scoutmaster Award of Merit, jacket patch, No. 00147, Scouter, centered on back of red jacket or jac-shirt. A knot, No. 05001, is also available.



Honor Medal (may also be awarded with Crossed Palms affixed to the ribbon)



Medal of Merit (yellow, blue, yellow ribbon)



Heroism Award (red, white, red ribbon)



George Meany Award, ribbon and pendant, Union Scouter for community services, formal wear as illustrated. A knot and cloth insignia are available. Available on a restricted basis from the Relationships Division at the national office.

Explorer Leadership Award, blue ribbon with Explorer medal, No. 04114, for council-level Explorer; red ribbon with Explorer medal, No. 04115, for area/regional Explorer; for Explorers, formal wear.



Spurgeon Award, lapel pin, No. 04157, and knot, No. 05021, Explorer leader, civilian wear.

Honor Medal, bar pin, red ribbon and pendant, awarded to a member of the Boy Scouts of America for saving life, above left pocket; embroidered red knot on tan, No. 05010, above left pocket. May also be awarded with Crossed Palms. Available on a restricted basis from Council Services Division at the national office.

Heroism Award, white and red ribbon and pendant, awarded to a member of the Boy Scouts of America for meritorious action, above left pocket; embroidered red knot on white twill, No. 05020, above left pocket. May be worn also by previous recipients of the Certificate for Heroism. Available on a restricted basis from Council Services Division at the national office.

Medal of Merit, gold and blue ribbon and pendant, awarded to a member of the Boy Scouts of America for meritorious action, above left pocket; embroidered gold and blue knot, blue to right, No. 05013, above left pocket. Available on a restricted basis from Council Services Division at the national office.

RELIGIOUS RECOGNITIONS FOR ADULTS

Adult religious recognitions consist of a pendant suspended from a ribbon worn around the neck. Adult religious emblems are generally worn only on formal occasions.



Allaho Akber Award
Islamic



Distinguished Youth Service Award
Association of Unity Churches



Faithful Servant Award
Churches of Christ



David Zeisberger Award
Moravian Church in America



Friends Award
Religious Society of Friends (Quakers)



God and Service
Protestant



United
Methodist



Presbyterian
Church (U.S.A.)

God and Service Award



Bishop Zelinski Award
Polish National Catholic Church



Good Shepherd Award
Baptist



International Youth Service Award
Reorganized Church of Jesus Christ of
Latter Day Saints



Lamb Award
Lutheran

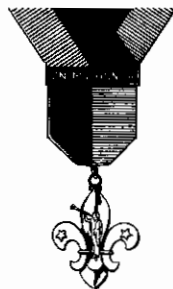

On My Honor Award
Church of Jesus Christ of Latter-day Saints



Prophet Elias Award
Eastern Orthodox Church



Religion and Youth Award
Unitarian Universalist Association



Scouter's Award
The Salvation Army



Scouter religious emblem square knot, cloth, purple knot on silver background, No. 05014, Scouter who has received an adult religious recognition, above left pocket.



Saint George Award
Episcopal



Saint George Award
Roman Catholic
Eastern Rite Catholic



Shofar Award
Jewish

Note: For additional information on religious emblems, write for Religious Emblems Programs flier, No. 5-206A, from the Relationships Division, S226, Boy Scouts of America, 1325 West Walnut Hill Lane, P.O. Box 152079, Irving, TX 75015-2079.

TRAINING RECOGNITIONS



Identification



Conference participants

Philmont Training Center, cloth, Scouter, right pocket of uniform shirt or red jacket.



Arrowhead Honor, cloth, No. 00933, commissioner only, left sleeve on long-sleeved shirts. For short-sleeved shirt, the commissioner badge of office may be moved to touch the council shoulder stripe (to accommodate the Arrowhead Honor award). Worn only with a commissioner badge of office.



Trained Leader emblem, No. 00280, is available for all leaders who have completed the basic training program appropriate to their positions. The emblem is worn immediately below and touching the emblem of office for which it was earned. Commissioners wear this emblem between the emblem of office and the Arrowhead Honor. Boy Scout junior leaders who have completed troop junior leader training, den chiefs who have completed the den chief training conference, and elected Explorers who have completed the post officer's seminar may wear the Trained Leader emblem beneath their badge of office.

Note: The Trained Leader emblem may be worn *only* in connection with the emblem of office for which basic training has been completed.

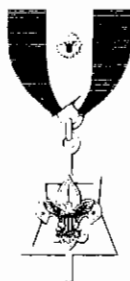

Commissioner Key/District Committee Key, green ribbon with broad white stripe and pendant. No. 00924, above left pocket; embroidered green and white knot, green to right, No. 05006, above left pocket. Commissioner wears commissioner device, No. 00929, on ribbon and/or knot. District committee members wear metal device, No. 00914 (see note on page 45).



World Crest, cloth, No. 00143, Scout leaders, centered horizontally over the left pocket and vertically between the left shoulder seam and the top of the pocket. May be worn by all members as an expression of world brotherhood.



Scouter's Training Award, green ribbon with narrow white stripe, and pendant, No. 00922, above left pocket; embroidered green knot on tan, No. 05008, above left pocket. Trained roundtable staff wears pendant and/or embroidered square knot with Cub Scout or Boy Scout device, depending on staff members' roundtables (see note on page 45).



International jacket patch



International activity patch

International: activity patch, No. 00144, Boy Scout and Boy Scout leader, worn as a temporary patch on right pocket; jacket patch, No. 00145, Boy Scout and Boy Scout leader, centered on back of jacket.

NAMEPLATES



Nameplate, white letters on black plastic, No. 20100. Worn by all members, worn above BSA strip or above interpreter strip, top edge of left breast pocket on male dress uniform. Worn on right lapel of female dress uniform.

International Youth Exchange, No. ID-214, a temporary patch worn on the right pocket. Available on a restricted basis from the International Division at the national office.

JAMBOREES



10th World Jamboree
Holland 1995



A jamboree emblem is worn above right pocket by a Boy Scout or Scouter who is registered to attend or attended the jamboree as a registered participant or staff member. Only one jamboree emblem (world or national) may be worn.

MEDALS AND EMBROIDERED KNOTS



Award of Merit



Silver World Award



Sea Badge

Wearing medals and embroidered knots. Only five medals may be worn at a time pinned in a single row immediately above the seam of the left pocket. Knots are worn above the left pocket in rows of three. The order of wearing of medals and knots is at the discretion of the wearer. It is suggested that the medal or knot deemed most important by the wearer be worn on his or her own right. Embroidered knots are representative of pin-on medals or around-the-neck awards and are designed for greater convenience of the wearer. In the case of the Award of Merit and Professional Training Award, the knot is the only wearable insignia. The knots are listed here in alphabetical order.

Arrow of Light Award, cloth, red and green knot, green to right, No. 05018, Scouter only, above left pocket.

Award of Merit, cloth, silver overhand knot, ends down, No. 05013, district or Exploring Division Scouter, above left pocket.

Cubmaster Award, cloth, blue knot on yellow, No. 05022, Cub Scouter, above left pocket.

Cub Scouter Award, cloth, blue and gold knot on dark blue, No. 05017, Cub Scouter, above left pocket.

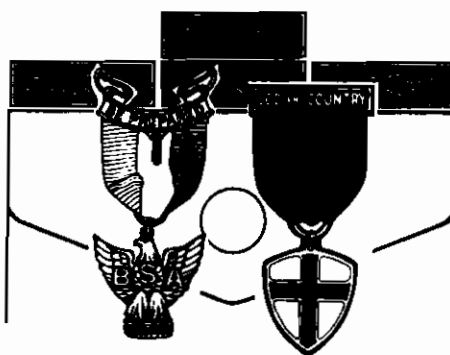

Den Leader Award, cloth, gold knot on blue, No. 05016, Cub Scouter, above left pocket.

Den Leader Coach Award, cloth, blue knot on dark blue, No. 05023, Cub Scouter, above left pocket.

Distinguished Commissioner Service Award, cloth, silver knot on red, No. 05019, Scouter, above left pocket. The primary award is a plaque with a metallic medallion: silver for council commissioner and assistants; gold for district commissioners and assistants and roundtable commissioners; and bronze for unit commissioners.

Eagle Award, cloth, red, white, and blue knot on tan, No. 05011, Scouter, above left pocket.

Embroidered knots from other Scout associations, Scouter, above left pocket.

Explorer Achievement Award, cloth, silver knot on red, white, and blue background (red to wearer's right), No. 05526, Explorer or Scouter, above left pocket. This knot also is worn by a Scouter who earned the Explorer Silver Award, Ranger, Air Explorer Ace, or Young American Award while a youth member.

George Meany Award, cloth, blue knot on red and white, restricted, Scouter, above left pocket. Available only from the Relationships Division.

Heroism Award, cloth, red on white twill, No. 05020, member of the Boy Scouts of America who has received this award or its predecessor, the Certificate for Heroism, above left pocket.

Honor Medal, cloth, red knot on tan, No. 05010, member of the Boy Scouts of America, for saving life, above left pocket.

Hornaday Award, cloth, blue, green, and white knot on tan, Boy Scout, Varsity Scout, Explorer, or Scouter, above left pocket.

Medal of Merit, cloth, gold and blue on tan, blue to right, No. 05025, member of the Boy Scouts of America for meritorious service, above left pocket.

Order of the Arrow Distinguished Service Award, cloth, white knot on red, No. 05528, Scout or Scouter, above left pocket.

Professional Training Award, cloth, black knot on white, Scouter, above left pocket. Available only from Professional Development Division.

Tiger Cub Group Coach Award, cloth, orange and black knot on orange, No. 17688, Cub Scouter, above left pocket.

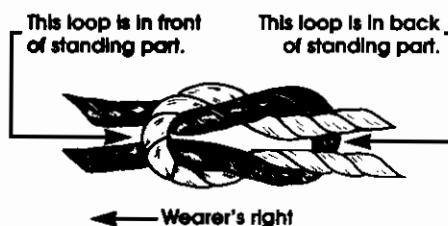

Right side up. The loop of the embroidered square knot that comes in *front* of the standing part is always to the wearer's right. In knots where both strands are the same color and therefore difficult to distinguish which strand comes in front, use the above drawing to determine wearer's right. Knots are worn with the distinguishing color (not white) toward the wearer's right. Other knots are worn as pictured on this page.

Quartermaster Award, cloth, navy blue knot on white, No. 05009, Sea Explorer or leader, above left pocket.

***Religious emblem square knot**, cloth, silver knot on purple, No. 05007, youth member or Scouter, above left pocket; cloth, purple knot on silver, No. 05014, Scouter only, above left pocket.

†**Scouter's Key**, cloth, green and white knot on tan, green to right, No. 05006, Scouter, above left pocket.

†**Scouter's Training Award**, cloth, green knot on tan, No. 05008, Scouter, above left pocket.

Scoutmaster Award of Merit, cloth, white knot on tan, No. 05001, Scouter, above left pocket.

Sea Badge, cloth, blue Neptune's spear on silver, No. 05527, Sea Exploring leader, above left pocket.

Silver Antelope Award, cloth, gold and white knot on tan, gold to right, No. 05005, regional Scouter, above left pocket.

Silver Beaver Award, cloth, blue and white knot on tan, blue to right, No. 05003, council Scouter, above left pocket.

Silver Buffalo Award, cloth, red and white knot on tan, red to right, No. 05004, national Scouter, above left pocket.

Silver Fawn Award, discontinued in 1974; wear Silver Beaver knot.

Silver World Award, cloth, red and white stripes, world, two stars to right, No. 05012, international Scouter, above left pocket.

Spurgeon Award, cloth, gold knot on dark green, No. 05021, Explorer leader, above left pocket.

Webelos Den Leader Award, cloth, gold knot on yellow, No. 05024, Cub Scouter, above left pocket.

Whitney M. Young Jr. Award, cloth, black and white knot on tan, No. 05015, Scouter, above left pocket. Available only from Council Services Division.

*The miniature device worn with the youth religious emblem square knot indicates emblem(s) earned as a youth. Wear Cub Scout device, No. 00926, first-level emblem (God and Me, Maccabee) earned as a Tiger Cub or Cub Scout; Webelos Scout device, No. 00932, for second-level emblem (God and Family, Parvuli Dei, Faith in God, Light of the World, Aleph, etc.) earned as a Webelos Scout; Boy Scout device, No. 00927, emblem earned as a Boy Scout; and/or Explorer device, No. 00930, emblem earned as an Explorer or older Boy Scout or Varsity Scout. Only one knot is worn, but any combination of devices may be worn on the same knot.

†The Scouter's Training Award and Scouter's Key may be earned in several program phases. More than one knot of the same kind is not to be worn. Rather, the miniature devices—No. 00926, Cub Scouting; (if earned prior to December 31, 1988) No. 00927, Boy Scouting; No. 00928, Varsity Scouting; No. 00931, Sea Exploring; No. 00929, commissioner or roundtable staff; No. 00914, District Committee Member; and/or No. 00930, Exploring—are worn on the knot to designate the phase(s) of the program in which the award or key was earned.

ORDER OF THE ARROW

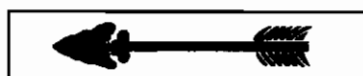

Ordeal sash



Order of the Arrow membership emblem

Order of the Arrow membership emblem, ribbon and pendant, No. 00001, Scout or Scouter, right pocket flap. Signifies national membership.

Order of the Arrow membership pin, No. 00002, Scout or Scouter, civilian wear only.

Ordeal sash, No. 02167, and long, No. 02168, Scout or Scouter, worn over right shoulder, under epaulet of tan shirt.

Brotherhood sash, No. 02169, and long, No. 02170, Scout or Scouter, worn over right shoulder, under epaulet of tan shirt.

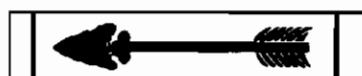

Brotherhood sash



Lodge insignia

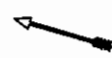

Pin

Vigil Honor sash, No. 02165, and long, No. 02166, Scout or Scouter, worn over right shoulder, under epaulet of tan shirt.

"Legend strips" or "sash backs" are not official and may not be worn on the sash or with the uniform. The OA sash is not worn with the merit badge sash.

Vigil Honor pin, No. 00008, Scout or Scouter, civilian wear, and worn on ribbon of Order of the Arrow membership emblem.

Section adviser, badge of office, No. 02204, area Scouter, left sleeve, position 3.



Vigil Honor sash



Vigil Honor



Jacket patch

Lodge adviser, badge of office, No. 02205, council Scouter, left sleeve, position 3.

Chapter adviser, badge of office, No. 02206, council Scouter, left sleeve, position 3.

Lodge insignia, Scout or Scouter, right pocket flap. Each lodge may have its own embroidered design. Must fit the exact size and shape of uniform pocket flap.

Order of the Arrow jacket patch, No. 00009, Scout or Scouter, centered on back of red jacket or jacket shirt.

SCOUTER DRESS UNIFORMS



All dress uniforms are worn with a red, white, and blue universal tie. Men's tie, regular, No. 00724; men's tie, long, No. 00725; ladies' scarf, No. 92102; scarf ring, No. 00128.

Detachable emblems are worn on the left pocket (left lapel for women) of the dress uniform to indicate the program phase of the wearer: universal, No. 00355; Cub Scout, No. 00350; Boy Scout, No. 00251; Explorer, No. 04005.

Dress uniforms are worn with white shirts or blouses.

REGIONAL INSIGNIA



NATIONAL EAGLE SCOUT ASSOCIATION



National Eagle Scout Association emblem

NESA pin, No. 02518, Boy Scout or Scouter, civilian wear.

NESA pocket emblem, No. 02509, cloth, Boy Scout or Scouter, right pocket.

NESA jacket emblem, 6-inch diameter, No. 02510, Boy Scout or Scouter, centered on back of jacket.

NATIONAL CAMPING SCHOOL



National Camping School emblem

National Camping School emblem, cloth, No. 00276, council Scouter, right pocket; staff emblem, cloth, No. 00277, Scouter, right pocket; jacket patch, No. 00278, centered on back of jacket.



National Camping School jacket patch

Regional Scouters wear regional insignia on the right sleeve in the second position. This insignia is reserved for regional office holders only, i.e., professionals, committee members, and officers. Exception: adult national and/or world jamboree leaders, but only during these events. This also applies to regional patches designed specifically for a national event.

Flags

The following pages contain information about unit and special flags. For special U.S. flag interpretation consult *Your Flag*, No. 3188, Boy Scouts of America.

The hand-to-forehead salute is correct for flag ceremonies for any person wearing a uniform of the Boy Scouts of America. This includes those wearing the blue blazer dress uniform. The hand-over-heart salute should be used when not in uniform.

SPECIAL FLAG DECORATIONS

Gold stars (memorial). Gold stars may be affixed to the unit flag indicating members of the unit who died in the service of their country. They should be placed along the staff edge of the flag, parallel to the staff, with the bottom star 6 inches from the staff edge and 6 inches from the bottom edge; subsequent stars to be placed proportionately on that line, up to the place assigned to the veteran insignia, No. 11117.

Veteran insignia. Veteran insignia is affixed to unit and local council flags midway between the top and bottom of the flag and midway between the pole and the flag emblem.

Fringes, cords, and tassels. Fringes, Nos. 11035 and 11036, and cords and tassels, No. 11037, may be used on local council, district, and unit flags (but not den or patrol flags) if desired by the persons or committee purchasing them.

SPECIAL FLAGS

Drum and bugle corps. Local councils having a drum and bugle corps made up of boys from different units may put the lettering "Drum and Bugle Corps" in a line at the bottom of their council flag. A unit drum and bugle corps may carry its unit flag but without special designation.

Boy Scouts of America flag. Purple flag with silver emblem.

Regional flag. Purple flag with silver emblem and lettering. Name of state may be added if desired.

Local council flag. Dark blue flag with gold emblem and lettering. Name of council on the upper half, headquarters city and state on the lower half.

District flag. Dark blue flag with gold emblem and lettering. Name or number of district on upper half, name of local council on lower half. Headquarters city and/or state optional.

Unit flags. For size and materials, refer to Flag Order Form, No. 70-421.

Lettering unit flags. The standard format that must be followed does not permit variations in the location of the lettering on the flag.

Top Half of Flag:

- Type of unit (pack, troop, post, or ship)
- Unit number (such as No. 10 or just the numeral 10)
- Chartered organization (if desired)

Lower Half of Flag:

- Location (town, community, school district, etc.)
- State (usually abbreviated)
- Council (if desired)

Explorer units with a unit name may add this to their flag. **No other lettering is permitted.**

Pack flag. Gold and blue.

Junior leader training flag. First line: Junior Leader Training. Second line: [special name of course, if desired]. Third line: [council name].

Council camp flag. Dark blue flag with gold emblem and lettering indicating name of camp and council.

Den flag. Gold on dark blue background, No. 11017. Den numbers are sold in pairs and may be attached on both sides of flag in upper corner farthest from staff; Nos. 11200 to 11209 (last two digits indicate the den number).

Webelos den flag. Light blue and gold on a dark blue background, No. 11114. Den numbers are sold in pairs and may be attached on both sides of flag in upper corner farthest from staff; Nos. 11200 to 11209 (last two digits indicate the den number).



District flag



Local council flag



Council camp flag

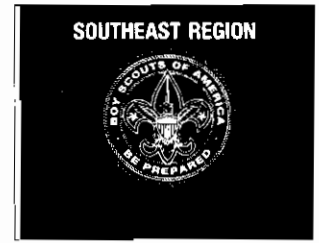

Regional flag



Boy Scouts of America flag



Troop flag

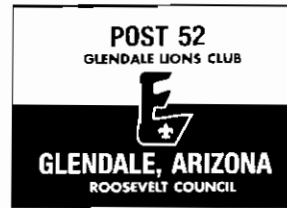

Post flag



Ship flag



Units in other countries



Varsity Scout team flag



Junior leader training flag



Pack flag



Den flag



Webelos den flag

Troop flag. Red and white.

Varsity Scout team flag. Blaze and brown with Scout emblem.

Post flag. Red and blue.

Ship flag. Red and blue.

Units in other countries. Unit flags may be lettered with the name of the country appearing after the name of the community.

Index

- Able Sea Explorer, 32
- Achievement, inside front cover
- Ad Altare Dei, 25
- Alph, 14
- Allaho Akber, 42
- Alpha Omega, 25
- Apprentice Sea Explorer, 32
- Aquatics instructor, BSA, 24
- Ararat, 25
- Area
 - committee, 37
 - president, 37
- Armenian
 - Apostolic Church of America (Western Prelacy), 26
 - Church of America, Eastern Diocese of the, 15, 25
- Arrowhead Honor, 43
- Arrow of Light, 10, 22, 44
- Arrow Point
 - Gold, 10
 - Silver, 10
- Assistant
 - council commissioner, 37
 - crew leader, 33
 - Cubmaster, 12
 - den leader, 12
 - denner, 12
 - patrol leader, 18
 - team Coach, 28
 - ranger, 39
 - Scoutmaster, 18
 - Scoutmaster—Varsity, 19
 - Scoutmaster—Venture, 24
 - senior patrol leader, 18
 - Webelos den leader, 12
- Association of Unity Churches, 15
- Attendance pin, 13, 23
- Aviation Exploring, 29, 30
- Award of Merit, 44
- Awards from other Scout associations, 3, 44
- Baden-Powell Patrol star, 16, 23
- Badges and insignia
 - alteration of, 2
 - authorization of, 2
 - other organizations, 3
 - other Scout associations, 3, 44
 - protection of, 1–2
 - special, 2
- Badges of office, 12, 18–19, 28, 32–33, 36–39
- Badges of rank, 5, 10, 22, 32
- Badge swapping, 3
- Baptist, 25, 42
- Bear badge, 10
- Belt loops, 11
- Belts, 7
- Bismillah, 14
- Blue blazer emblems, 46
- Bobcat, 10
- Bolo tie, 9, 17
- Boy Scout
 - advancement, 22
 - badge, 22
 - emblem, 17
 - flag, 47–48
 - immediate recognition, 19
 - jac-shirt or jacket emblem, 27
 - Leader's Training Award, 27
 - program identification, 16–17
 - roundtable commissioner, 38
 - roundtable staff, 38
- Brotherhood sash, 45
- BSA Lifeguard, 24, 33
- Buddhist, 15, 26
- Bugler, 19, 33
- Campmaster, 38
- Camp staff, 38
- Captain, 19, 28
- Chaplain, 18, 38
- Chaplain aide, 18
- Chapter adviser, 45
- Charles L. Sommers National High Adventure Base, 23, 34
- Chartered organization
 - representative, 36, 37
- Chi Rho, 14
- Chief Scout Executive, 36
- Churches of Christ, 15, 25, 42
- Church of Jesus Christ of Latter-day Saints, 14, 26, 42
- Coach, 28
- Cocaptain, 28
- Commissioner
 - Key, 43
 - Training Award, 43
- Compassionate Father, 25
- Contest medal, 24
- Council
 - commissioner, 37
 - committee, 37
 - executive board, 37
 - flags, 47–48
 - international representative, 37
 - past president, 37
 - president, 37
 - shoulder emblem, 4, 9, 16, 36
 - vice-president, 37
 - crew chief, Venture, 19, 28
- Crossed Palms, 41
- Cubmaster, 12
 - Award, 14, 44
- Cub Scout
 - activity medals, 13
 - advancement, 10
 - leader recognition, 13–14
 - program identification, 9
 - religious emblems, 14–15
 - roundtable commissioner, 38
 - roundtable staff, 38
 - sports and academics program, 11
- Cub Scouter Award, 14, 44
- Den
 - chief, 18
 - Chief Service Award, 24
 - chief shoulder cord, 18
 - flag, 47–48
 - leader, 12
 - Leader Award, 14, 44
 - leader coach, 12
 - Leader Coach Award, 14, 44
 - numeral, 9
- Denner shoulder cord, 12
- Distinguished Commissioner Service
 - Award, 44
- Distinguished Eagle Scout Award, 41
- Distinguished Youth Service Award, 42
- District
 - chairman, 38
 - commissioner, 38
 - committee, 38
 - director, 39
 - executive, 39
 - insignia, 4
- flag, 47–48
- Dress uniform, 46
- Drum and bugle corps, 4, 47
- Musician badge, 4, 16, 19
- Eagle
 - Award, 22, 44
 - Palms, 22
 - required merit badges, 20
- Eastern Orthodox, 14, 15, 25, 42
- Eastern Rite Catholic, 26
- Embroidered knots, 44–45
- Employee, 39
- Episcopal, 14, 25, 34, 42
- Explorer
 - Achievement Award, 33, 44
 - E jacket emblem, 29
 - Leadership Award, 41
 - officers association, 34
 - program identification, 29–30
- Explorer post
 - Advisor, 32
 - associate Advisor, 32
 - committee, 32
 - president, 32
 - secretary, 32
 - Skipper, 32
 - treasurer, 32
 - vice-president, 32
- Exploring
 - Key, 35
 - Training Award, 35
 - service team pin, 38
- Excess insignia, 4
- Faithful Servant Award, 42
- Faith in God, 14
- 50-Miler, 23, 33
- First Class, 22
- Flags, 47–48
- Florida High Adventure Sea Base, 23, 34
- Friends Award, 42
- Friends, Religious Society of (Quakers), 15, 26, 42
- Fringes, cords, and tassels, 47
- General Church of the New Jerusalem, 26
- George Meany Award, 41, 44
- God and Church, 26
- God and Country, 14, 25, 34
- God and Family, 15
- God and Life, 34
- God and Service, 42
- God and Me, 14
- God and The Salvation Army, 25
- God in Me, 15
- Gold star memorials, 47
- Good Servant, 25
- Good Shepherd, 42
- Headgear regulations, 3
- Heroism Award, 41, 44
- High adventure, 5, 23, 34
- Historian, 19
- Historic Trails Award, 23, 33
- Honor Medal, 41, 44
- Hornaday Award and badge, 23, 33, 44
- Immediate recognition kit, 19
- Instructor, 18
- International
 - activity patch, 24, 43
 - commissioner, 36
 - representative, 37
 - Youth Service Award, 42
- Interpreter strip, 16, 23
- In the Name of God, 25
- Islamic, 14, 25
- Jacket insignia, 5, 45, 46
- Jamboree insignia, 4, 16, 43
- Jewish, 8, 14, 26, 42
- Joyful Servant, 15
- Junior assistant Scoutmaster, 18
- Junior leader training, 27
- Lamb, 42
- Law Enforcement Explorer
 - proficiency ribbons, 30
- Law Explorer, 29
- Liahona, 26
- Librarian, 18
- Life, 22
- Light Is Life, 26
- Light of the World, 15
- Living Faith, 34
- Lodge insignia, 45
- Lone Scout emblem, 9, 16
- Lone Scout neckerchief, 6
- Long Cruise badge, 34
- Love and Help, 15
- Love for God, 15
- Love of God, 15
- Lutheran, 14, 26, 42
- Maccabee, 8
- Medal of Merit, 41, 44
- Meher Baba, 15, 25
- Merit badges, 20–21
- Methodist, 25, 42
- Metta, 15
- Mill Swim, BSA, 23, 33
- Miniature of the badges of rank;
 - see Bobcat, Wolf, Bear, Webelos, Tenderfoot, Second Class, First Class, Star, Life, Eagle
- Mormon; see Church of Jesus Christ of Latter-day Saints
- Musician, 4, 16, 19
- Nameplates, 43
- National
 - Ambassador, 37
 - Camping School, 46
 - Commissioner, 36
 - committee, 37
 - Executive Board, 36
 - executive staff, 36
 - Junior Leader Instructor Camp—Philmont, 27
 - partner representative, 37
 - past president, 36
 - president, 36
 - Summertime Pack Award, 13
 - vice-president, 36
- Neckerchief
 - how to wear, 7
 - part of uniform, 6, 17
 - slide, 6, 17
- Ner Tamid, 26
- NESA, 5, 46
- Northern Tier National High Adventure Programs, 23, 34
- Official
 - policy, inside front cover
 - uniforms, 1
- On My Honor, 26, 42
- Open Word, 26
- Optional merit badges, 20–21
- Ordeal sash, 45

- Order of the Arrow, 5, 16, 45
 Ordinary Sea Explorer, 32
 Organizer, 40
 Outdoor Adventure emblem, 30
 Outdoor program belt buckle, 12
- Pack
 chairman, 12
 committee, 12
- Palms, Eagle, 22
 Paraprofessional, 39
 Parvuli Dei, 15
 Patrol
 emblem, 16, 17
 leader, 18
 Paul Bunyan Woodsman, 23
 Personal
 commitment, inside front cover
 equality, inside front cover
 Phillmont, 5, 23, 27, 34, 43
 Physician, 38
 Pinewood derby medal, 13
 Pins, 3, 10, 24, 30, 31, 35, 39-40, 41, 45, 46
 Polish National Catholic Church, 15, 26
 Pope Pius XII, 34
 Post committee, 32
 Post flag, 48
 Presbyterian, 25, 42
 Professional Training Award, 44
 Program manager, 28
 Progress Toward Ranks, 10
 Prophet Elias Award, 42
 Protestant, 14, 25, 34
- Qualified seaman, 32
 Quality Unit, 9, 13, 16, 24, 29, 34
 Quartermaster, 18
 Award, 32, 45
- Ranger, 39
 Ranks, 10, 22
 Recruiter, 9, 13, 16, 23
 Regatta medal, 13
 Regional
 committee, 37
 flags, 47-48
 insignia, 46
 president, 37
 Religion and Youth, 42
 Religion in Life, 26
 Religious emblems, 8, 14-15, 24-25, 34, 42
 Reorganized Church of Jesus Christ of Latter Day Saints, 14, 26, 34, 42
 Roman Catholic, 15, 25, 34, 42
 Roundtable staff, 38
 Rules and regulations, 1-6
- Saint George, 15, 42
 Saint Gregory, 15
- Saint Mesrob, 26
 Salvation Army
 Boy Scout emblem, 25, 34
 Cub Scout emblems, 14, 15
 Scouter's Award, 42
 Sangha, 26
 Scouter's Key, 27, 35, 43, 45
 Scouter's Training Award, 27, 35, 43, 45
 Scout executive, 39
 Scouting identification, 6
 Scoutmaster, 18
 Award of Merit, 5, 41, 45
 Scoutmaster's Key, 27
 Scribe, 18
 Sea Badge, 35, 44, 45
 Sea Explorer
 advancement, 32
 Affiliation emblem, 30
 boatswain, 33
 bugler, 33
 council committee, 38
 crew leader, 33
 insignia, 31-33
 Leader's Training Award, 35
 mate, 33
 national committee, 37
 regional committee, 37
 purser, 33
 ship committee, 33
 Skipper, 32
 specialist, 33
 storekeeper, 33
 yeoman, 33
 Second Class, 22
 Section adviser, 45
 Senior district executive, 39
 Senior Exploring executive, 39
 Senior patrol leader, 18
 Service stars, 39-40
 Service team, 38
 Ship flags, 48
 Shofar, 42
 Shoulder loops, 7, 17, 28, 36
 Silver
 Antelope, 40, 45
 Beaver, 40, 45
 Buffalo, 41, 45
 Crest, 15
 Fawn, 45
 World, 44, 45
 Small-boat handler, 32
 Snorkeling, BSA, 23
 Space derby medal, 13
 Spirit of Truth, 26
 Sports pins, 24
 Spurgeon Award, 41, 45
 Squad leader, 28
 Square knots, 15, 22, 26, 34, 42, 44-45
 Standard Explorer unit, 34
 Star, 22
- Team
 Coach, 28
 committee, 28
 committee chairman, 28
 flag, 48
 Temporary Insignia, 5-6
 Tenderfoot, 22
 Thanks pin, 40
 That of God, 15
 Tiger Cub, 8
 Adult partner, 8
 Graduate emblem, 8, 13
 group coach, 8, 12
 Tiger tracks, 8
 Trained Leader emblem, 13, 16, 27, 29, 35, 36, 43
 Troop
 committee, 18
 committee chairman, 18
 flag, 48
 guide, 19
 historian, 19
 Two badges with some meaning, 5
- Uniforms
 distribution of, 1-2
 protection of, 1
 use of, 2
- Unit
 commissioner, 38
 flag, 47-48
 numeral, 9, 16
 Unitarian Universalist, 15, 26, 42
 Universal emblem, 36
 U.S. flag, 9, 16, 29, 36, 47
- Varsity Scout
 assistant Scoutmaster, 19
 badges of office, 19, 28
 insignia, 28
 letter, 28
 program identification, 28
 Varsity pins, 24
 Venture
 activities pins, 24
 assistant Scoutmaster, 19
 crew chief, 19
 letter, 20, 24
 Veteran
 flag insignia, 47
 recognitions, 40
 unit bars, 9, 16
 Vigil Honor sash and pin, 45
- Webelos
 activity badges, 10
 badge, 10
 colors, 10
 compass points emblem, 10
 den chief shoulder cord, 18
 den emblems, 9, 17
 den flag, 47
 den leader, 12
 Den Leader Award, 14, 45
 Whitney M. Young Jr. Service Award, 41, 45
 Wolf badge, 10
 Wood Badge, 27
- World
 Community, 15, 34
 Conservation Award, 13, 24
 Crest, 43

